



Enter Part#, Model#, or Keyword

Search

(1)

Ignition Parts

DUAL CIRCUIT	5-9 CIRCUIT	10 - 16 AMP	TRI CIRCUIT
474B 877	1059 474C 877B	474D 1059 877C	474C 1059 877B
87B	578A	578A	578A
	526A 501A	526B 501D	878A

NOTE: All Stators Use a No. 1119 Mounting Screw.

NOTE: The proper flywheel part number and/or the alternator magnet size will determine the alternator type or output. See repair instruction manual for additional information.

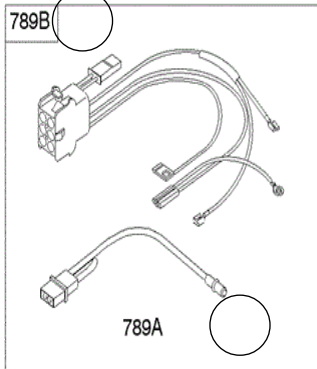



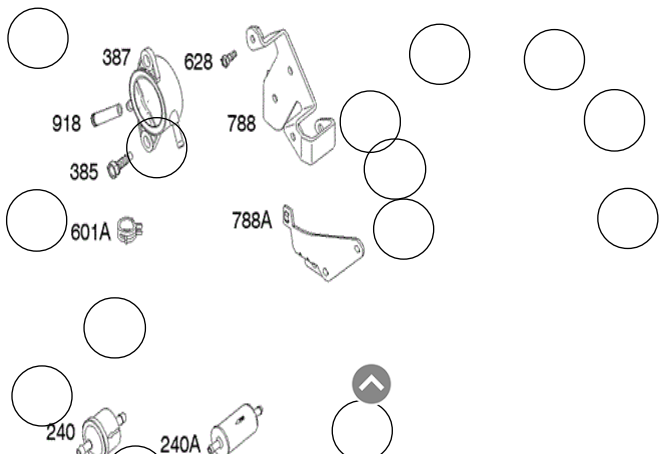
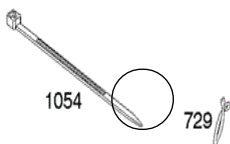
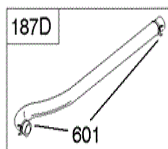
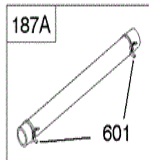
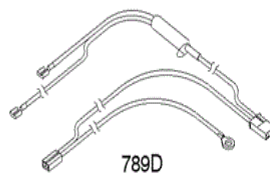

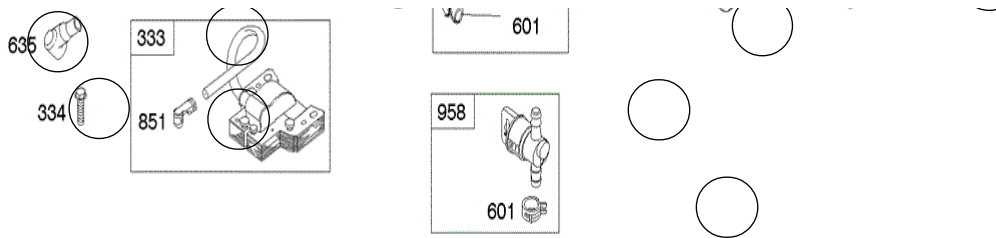









ARI PartStream™

















Copyright
Page design (c) 2004 - 2017 by ARI Network Services, Inc.

240	691035		Fuel Filter (https://www.jackssmallengines.com/jacks-parts-lookup/part/briggs-stratton/691035)	
333	592846		Magneto Armature (https://www.jackssmallengines.com/jacks-parts-lookup/part/briggs-stratton/592846)	
334	691061		Screw (https://www.jackssmallengines.com/jacks-parts-lookup/part/briggs-stratton/691061) (Magneto Armature)	\$1.95
385	691108		Screw (https://www.jackssmallengines.com/jacks-parts-lookup/part/briggs-stratton/691108) (Fuel Pump)	\$1.95
387	808656		Fuel Pump (https://www.jackssmallengines.com/jacks-parts-lookup/part/briggs-stratton/808656)	
474B	592831		Alternator (https://www.jackssmallengines.com/jacks-parts-lookup/part/briggs-stratton/592831) (Dual Circuit)	\$68.50
474D	592830		Alternator (https://www.jackssmallengines.com/jacks-parts-lookup/part/briggs-stratton/592830) (10-16 Amp Regulated)	\$68.50
474C	592829		Alternator (https://www.jackssmallengines.com/jacks-parts-lookup/part/briggs-stratton/592829) (Tri Circuit)	\$68.50
501A	794360		Regulator (https://www.jackssmallengines.com/jacks-parts-lookup/part/briggs-stratton/794360)	
501D	845907		Regulator (https://www.jackssmallengines.com/jacks-parts-lookup/part/briggs-stratton/845907)	
526A	691129		SCREW (https://www.jackssmallengines.com/jacks-parts-lookup/part/briggs-stratton/691129) (Regulator)	\$1.95
526B	691108		Screw (https://www.jackssmallengines.com/jacks-parts-lookup/part/briggs-stratton/691108) (Regulator)	\$1.95
578A	691208		Wire Assembly (https://www.jackssmallengines.com/jacks-parts-lookup/part/briggs-stratton/691208)	\$10.20
601	791850		Hose Clamp (https://www.jackssmallengines.com/jacks-parts-lookup/part/briggs-stratton/791850) (Green)	
601A	691038		Hose Clamp (https://www.jackssmallengines.com/jacks-parts-lookup/part/briggs-stratton/691038) (Black)	\$2.28



628	691108		Screw (https://www.jackssmallengines.com/jacks-parts-lookup/part/briggs-stratton/691108) (Fuel Pump Bracket) Used Before Code Date 06072800	\$1.95
635	66538S		Spark Plug Boot (https://www.jackssmallengines.com/jacks-parts-lookup/part/briggs-stratton/66538s)	
729	694123		CLIP WIRE (https://www.jackssmallengines.com/jacks-parts-lookup/part/briggs-stratton/694123)	\$2.30
788	691039		BRACKET FUEL PUMP (https://www.jackssmallengines.com/jacks-parts-lookup/part/briggs-stratton/691039) Used Before Code Date 06072800	\$15.00
788A	793145		BRACKET FUEL PUMP (https://www.jackssmallengines.com/jacks-parts-lookup/part/briggs-stratton/793145) Used After Code Date 08072700	\$11.95
789A	790544		WIRE/CONNECTOR ALT (https://www.jackssmallengines.com/jacks-parts-lookup/part/briggs-stratton/790544)	\$25.00
789B	698330		Wire Harness (https://www.jackssmallengines.com/jacks-parts-lookup/part/briggs-stratton/698330)	\$25.00
789D	691220		Wire Harness (https://www.jackssmallengines.com/jacks-parts-lookup/part/briggs-stratton/691220)	\$25.00
851	493880S		Spark Plug Terminal (https://www.jackssmallengines.com/jacks-parts-lookup/part/briggs-stratton/493880s)	
877	393456		Alternator Connector Wire (https://www.jackssmallengines.com/jacks-parts-lookup/part/briggs-stratton/393456)	\$12.83
877B	393537		WIRE/CONN ALTERNATOR (https://www.jackssmallengines.com/jacks-parts-lookup/part/briggs-stratton/393537)	No Longer Available
877C	399916		Alternator Wire Connector (https://www.jackssmallengines.com/jacks-parts-lookup/part/briggs-stratton/399916)	\$8.00
878	398661		Alternator Harness (https://www.jackssmallengines.com/jacks-parts-lookup/part/briggs-stratton/398661)	\$18.00
878A	691955		Wiring Harness (https://www.jackssmallengines.com/jacks-parts-lookup/part/briggs-stratton/691955)	\$40.38
918	793147		Vacuum Hose (https://www.jackssmallengines.com/jacks-parts-lookup/part/briggs-stratton/793147) Used After Code Date 06072700	
958	698183		Fuel Shut Off Valve (https://www.jackssmallengines.com/jacks-parts-lookup/part/briggs-stratton/698183) (Plastic)	
1054	280275		TIE CABLE (https://www.jackssmallengines.com/jacks-parts-lookup/part/briggs-stratton/280275)	\$2.50
1059	698516		KIT SCREW/WASHER (https://www.jackssmallengines.com/jacks-parts-lookup/part/briggs-stratton/698516) (Alternator)	\$3.35
NA	280275		TIE CABLE (https://www.jackssmallengines.com/jacks-parts-lookup/part/briggs-stratton/280275)	\$2.50

