

## Section 4

# GOV. CONTROLS & CARB. LINKAGE

### REMOTE CONTROLS

In general, there are three types of remote controls: Governor Control, Throttle Control, Choke-A-Matic Control. Fig. 1 to Fig. 6, show the operation of these control systems. See following pages for specific control assemblies and installation hook-up by engine model.

#### Remote Governor Control

The Remote Governor control regulates the engine speed by changing the governor spring tension, thus allowing the governor to control the carburetor throttle at all times and maintain any desired speed. Fig. 1.

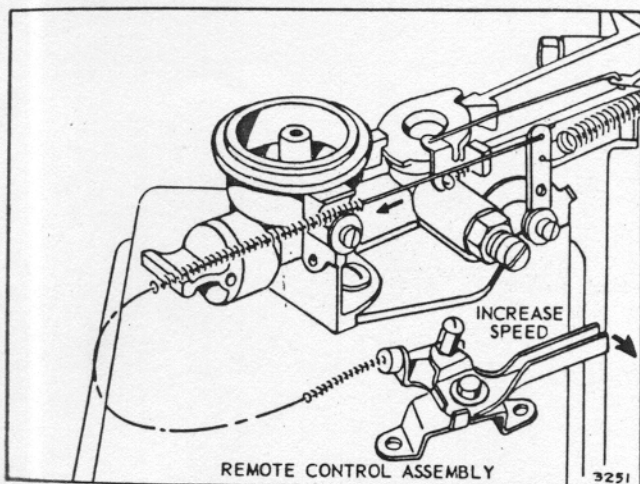

Fig. 1 - Remote Governor Control

#### Remote Throttle Control

The Remote Throttle control is used on an engine having a fixed no load governed speed setting such as 3600 or 4000 R.P.M.

This control enables an operator to control the speed of an engine, similar to an accelerator used on an automobile. However, when full governed speed is obtained, the governor prevents over speeding and possible damage to the engine. At any point below the governed speed, the throttle is held in a fixed position and the engine speed will vary with the load. See Fig. 2.

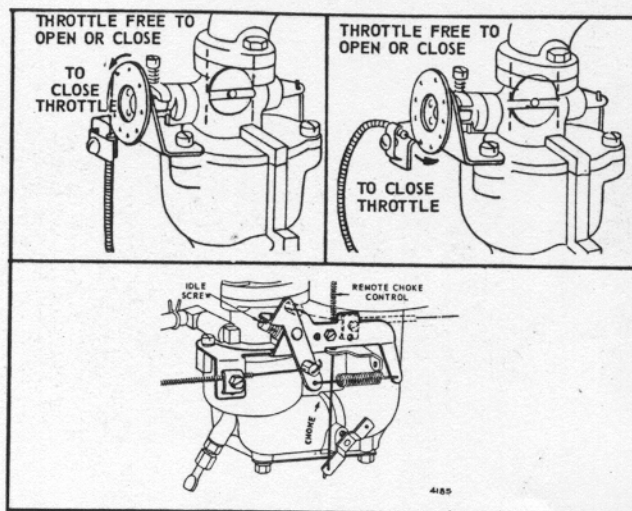

Fig. 2 - Remote Throttle Control

#### Choke-A-Matic Remote Control

On Choke-A-Matic carburetors, the remote control must be correctly adjusted in order to obtain proper operation of the choke and stop switch.

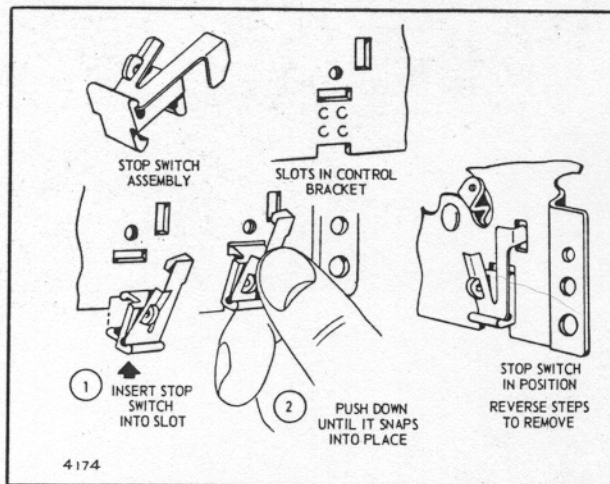

Fig. 3 - Typical Stop Switch Installation

NOTE: REMOTE CONTROL SYSTEM MUST BE MOUNTED ON POWERED EQUIPMENT IN NORMAL OPERATING POSITION BEFORE ADJUSTMENTS ARE MADE.

# GOV. CONTROLS & CARB. LINKAGE

## General

Fig. 4 illustrates typical remote control installations used with Choke-A-Matic carburetors. To adjust, move remote control lever to "FAST" position. Choke actuating lever "A" should just contact choke shaft "B" or link "B" as shown in Fig. 4. If not, loosen screw "C" slightly and move casing and wire "D" in or out to obtain this condition.

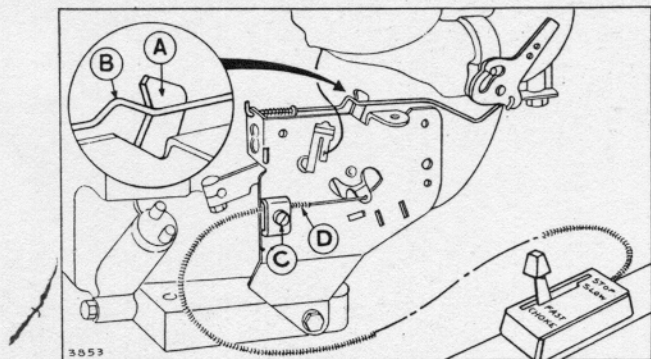
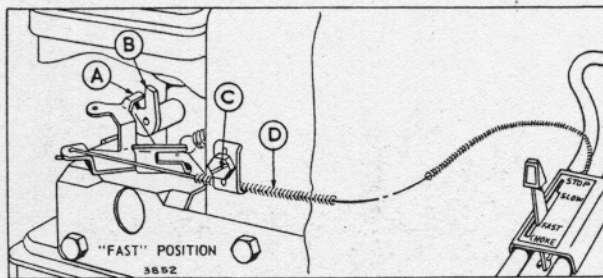
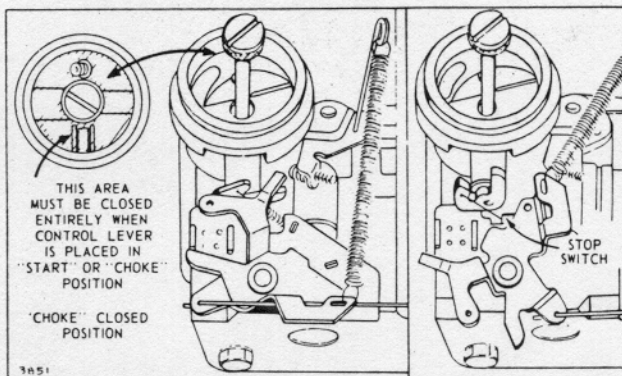

Fig. 4 - Choke-A-Matic Control (Typical)

Check operation by moving remote control lever to "START" or "CHOKE" position. Choke valve should be completely closed. Fig. 5. Illus. 1. Then move remote control lever to "STOP" position. Control must contact stop switch blade. Fig. 5. Illus. 2.



Illus. 1

Illus. 2

Fig. 5 - Choke and Stop Position

Travel of remote control wire must be a minimum of 1-3/8" in order to achieve full "CHOKE" and "STOP" position. Fig. 6.

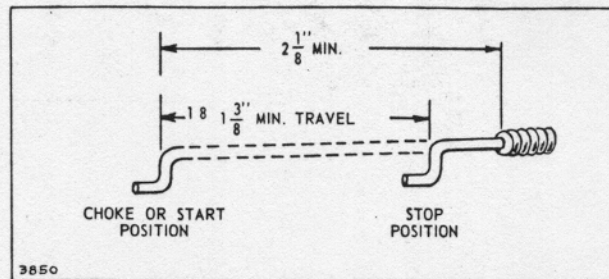

Fig. 6 - Control Wire Travel

## CHOKE-A-MATIC DIAL CONTROL ADJUSTMENTS

Dial Controls seldom require adjustment unless blower housing has been removed. To Adjust: Place dial control knob in "Start" position. Loosen control wire screw "A" - move lever "C" to full choke position. Allow a 1/8" gap between lever and bracket as shown.

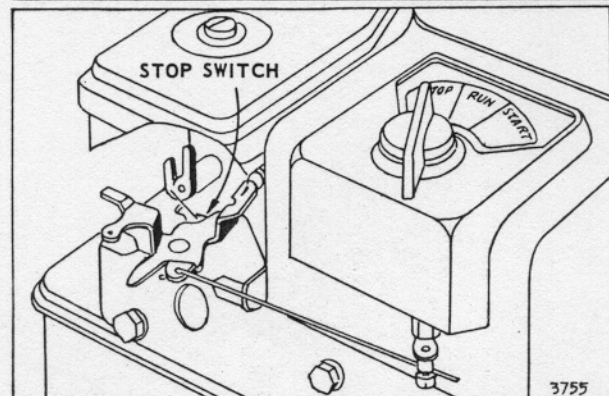
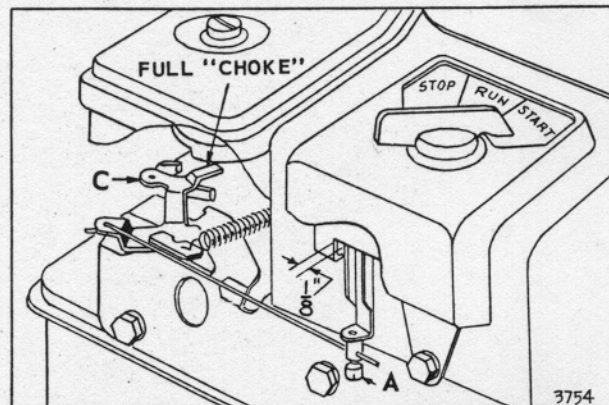

Fig. 7 - Choke-A-Matic Dial Control Adjustments



# GOV. CONTROLS & CARB. LINKAGE Models 6, 8, 60000, 80000 Horiz. Shaft

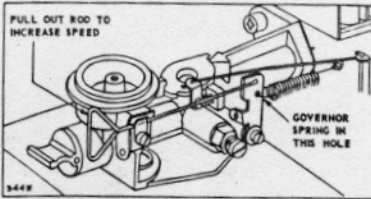

Fig. 8

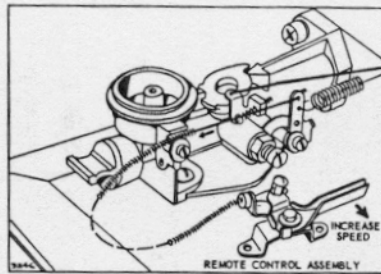

Fig. 9

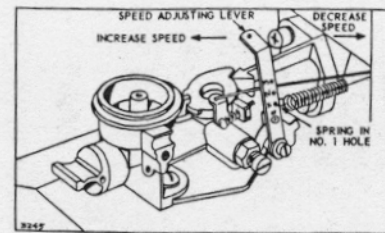

Fig. 10

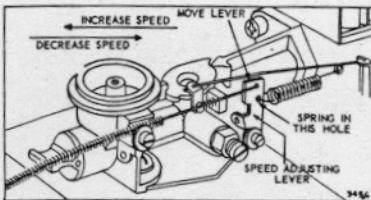

Fig. 11

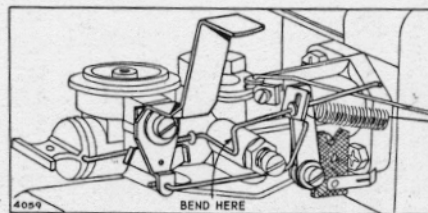

Fig. 12

Place lever in choke detent. If choke is not fully closed, bend link where shown to attain full choke.

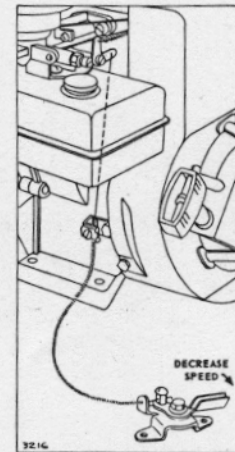

Fig. 13

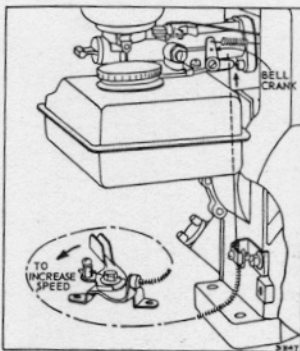

Fig. 14

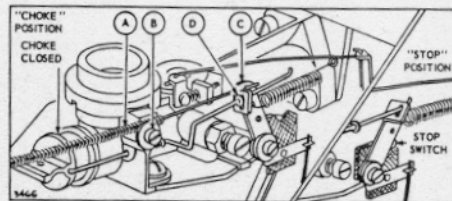

Fig. 15

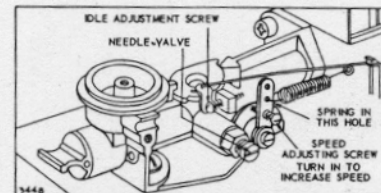

Fig. 16

MODELS 6BS, 60100, 61100, 80100, 81100

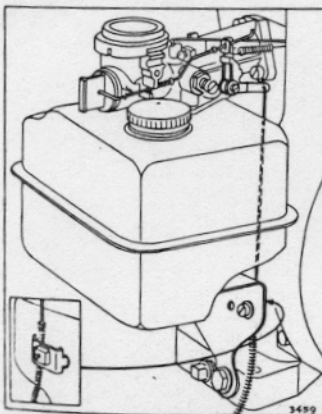

Fig. 17

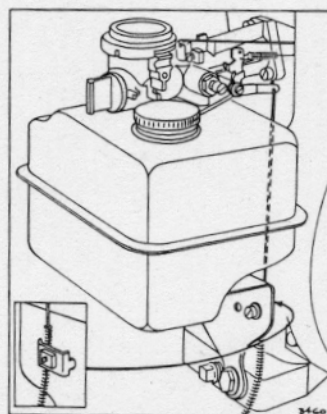

Fig. 18

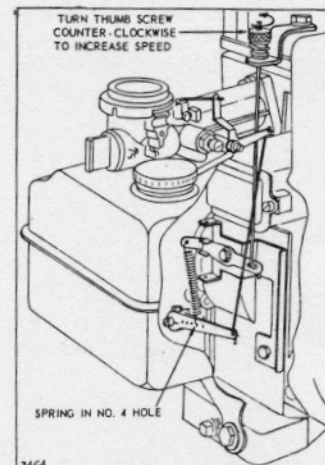

Fig. 19

MODELS 60200, 61200, 80200, 81200

# GOV. CONTROLS & CARB. LINKAGE Models 6, 8, 60000, 80000 Horiz. Shaft

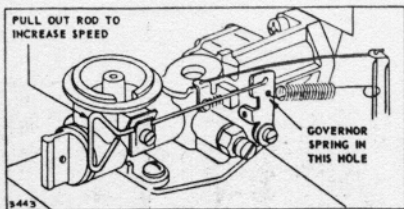

Fig. 20

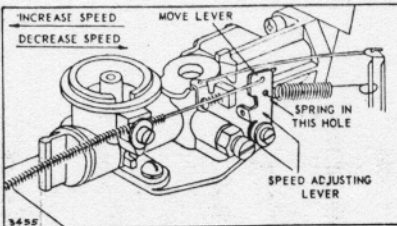

Fig. 21

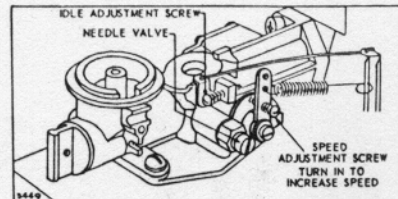

Fig. 22

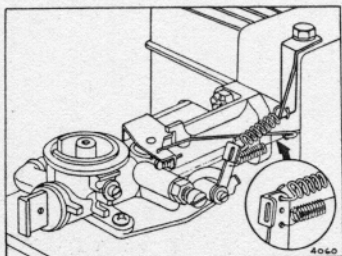

Fig. 23

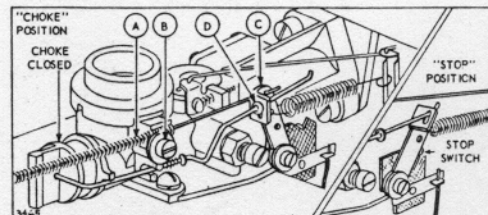

Fig. 24

MODELS 60200, 61200, 80200, 81200 (Cont'd.)

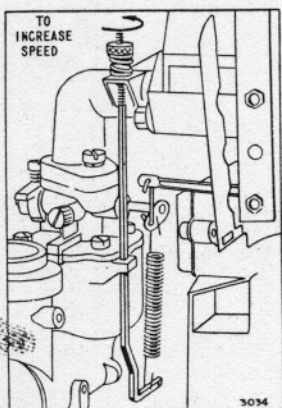

Fig. 25

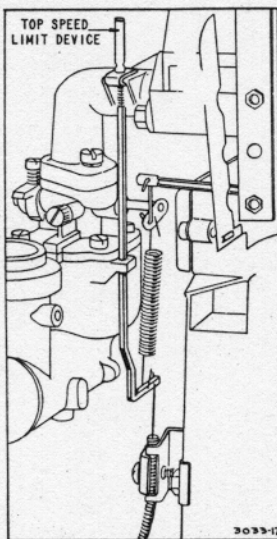

Fig. 26

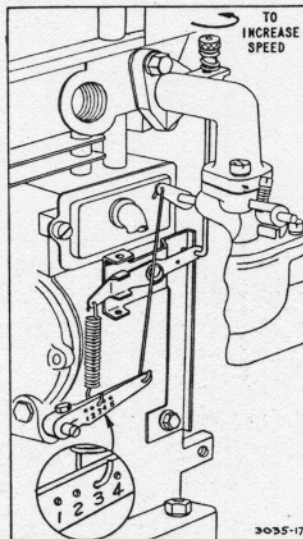

Fig. 27

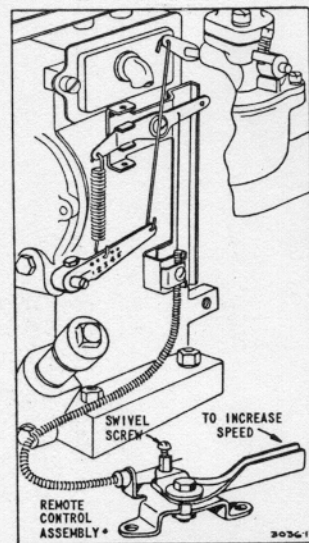

Fig. 28

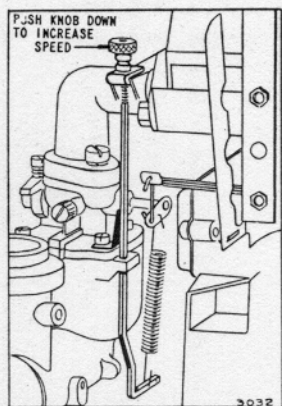

Fig. 29

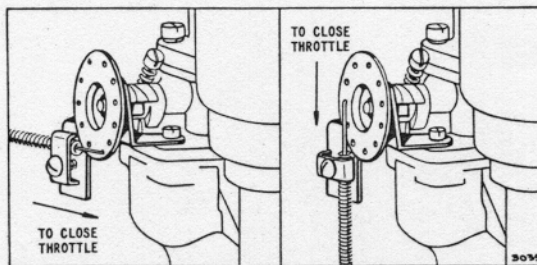

Fig. 30

MODELS 6B, 8B, 60300, 60400, 61300, 80300, 80400, 81400



# GOV. CONTROLS & CARB. LINKAGE Models 6, 8, 60000, 80000 Vertical Shaft

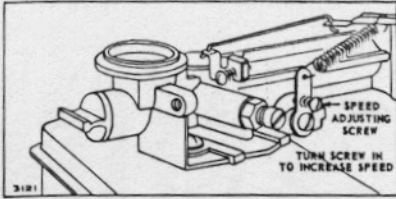

Fig. 31

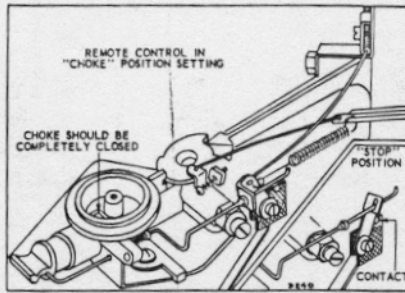

Fig. 32

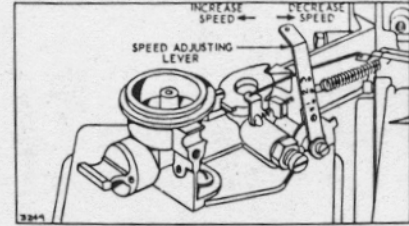

Fig. 33

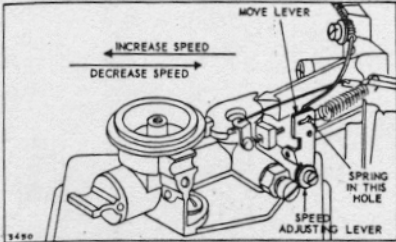

Fig. 34

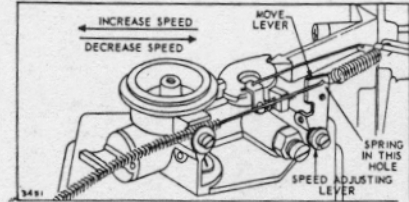

Fig. 35

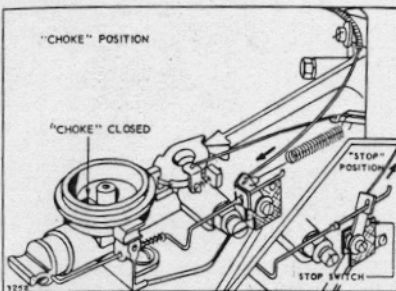

Fig. 36

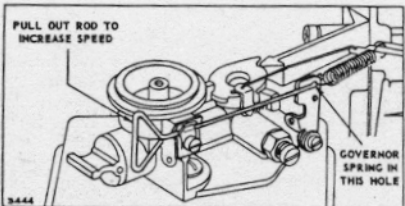

Fig. 37

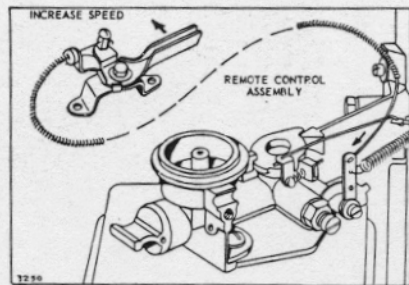

Fig. 38

MODELS 6BHs, 60500, 61500, 80500, 81500

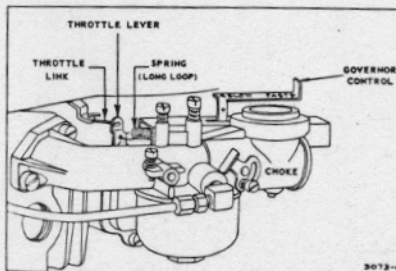

Fig. 39

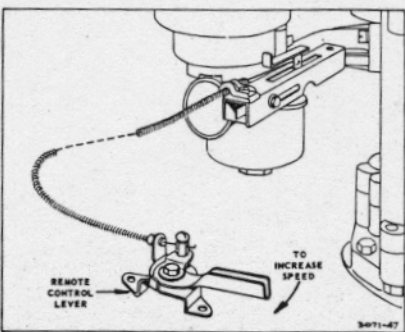

Fig. 40

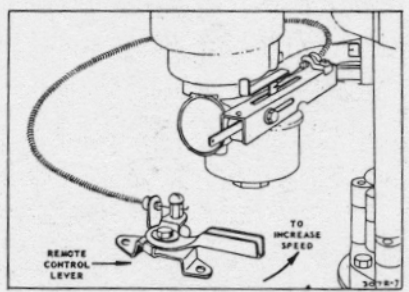

Fig. 41

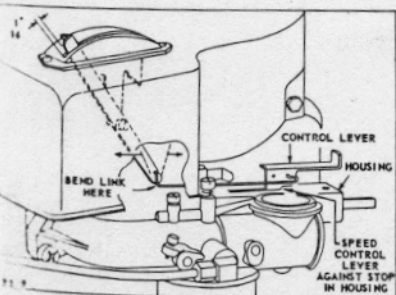

Fig. 42

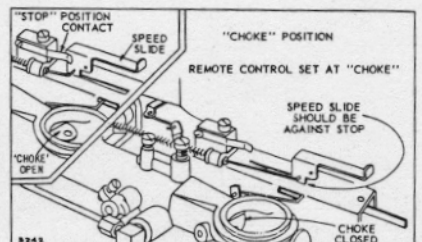

Fig. 43

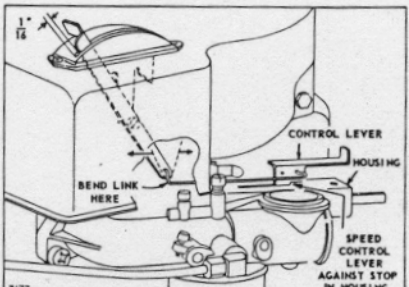

Fig. 44

MODELS 6B-H, 8B-HA, 60700, 61700, 80700, 81700

# GOV. CONTROLS & CARB. LINKAGE

## Models 6, 8, 60000, 80000, 82000, 92000 Vertical Shaft

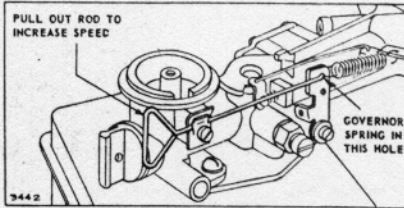

Fig. 45

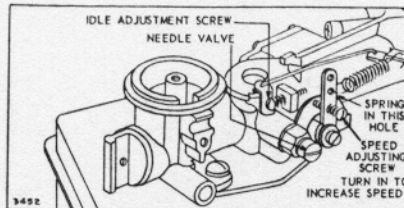

Fig. 46

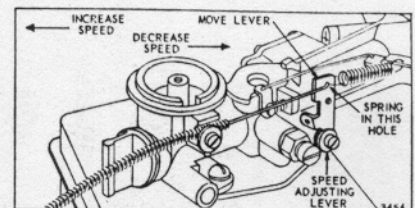

Fig. 47

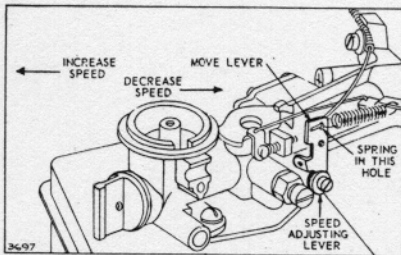

Fig. 48

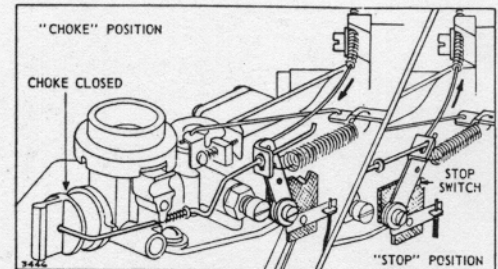

Fig. 49

MODELS 60900, 61900, 80900, 81900

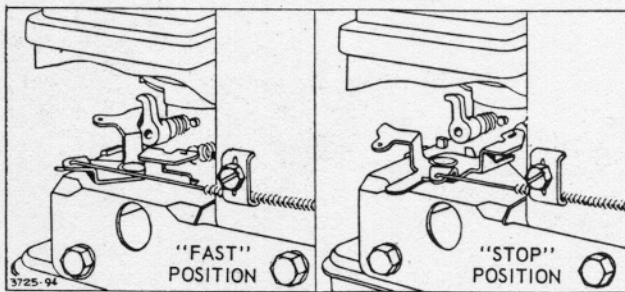

Fig. 50

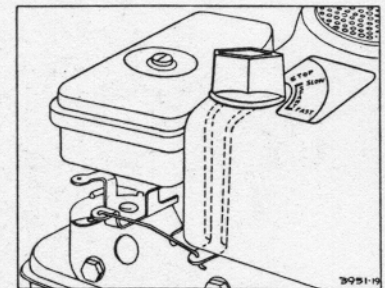

Fig. 52 - Dial-Trol Linkage

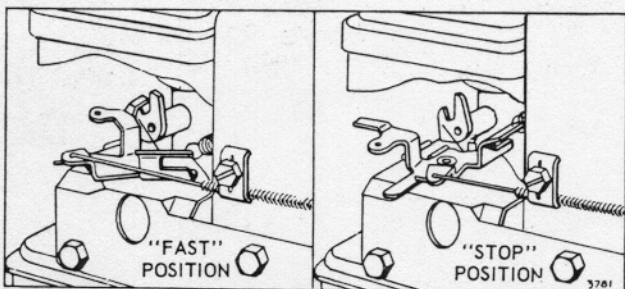

Fig. 51

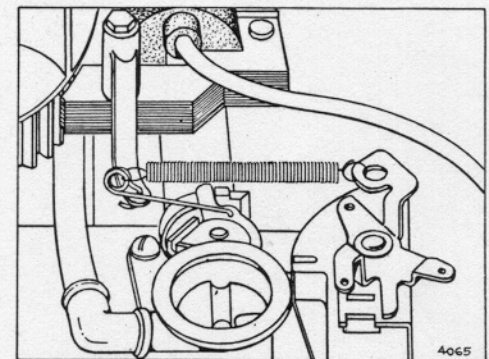

Fig. 53

MODELS 82000, 92000



REMOVAL AND INSTALLATION OF GOVERNOR SPRING ON  
MODEL SERIES 92500 AND 92900

The governor springs used on engine Model Series 92500 and 92900 are made with double end loops for a secure attachment and proper governor regulation. Springs with double end loops are easily removed and installed by fol-

lowing the procedure shown below. Do NOT use a needle-nosed pliers, or the end loops of the governor spring will be deformed. When the governor spring is correctly installed, the spring must be positioned as shown in Figure 54.

CORRECT POSITION OF SPRING

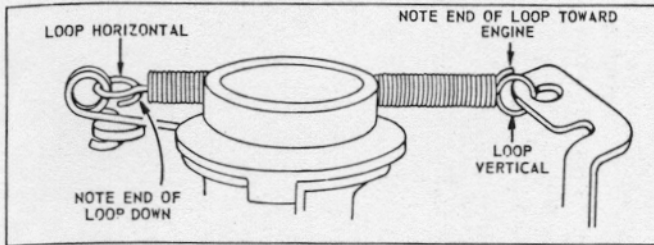

Fig. 54

REMOVING SPRING

1 REMOVE SPRING FROM CONTROL LEVER

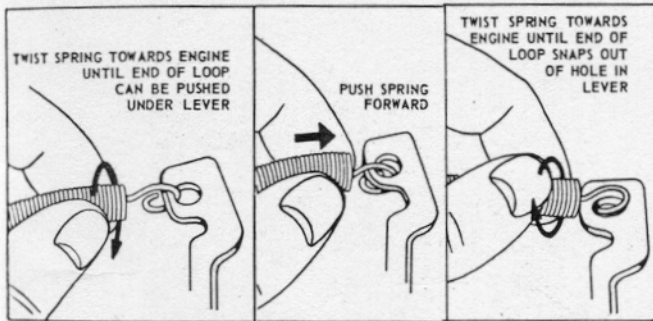

Fig. 55

2 REMOVE SPRING FROM EYELET IN LINK

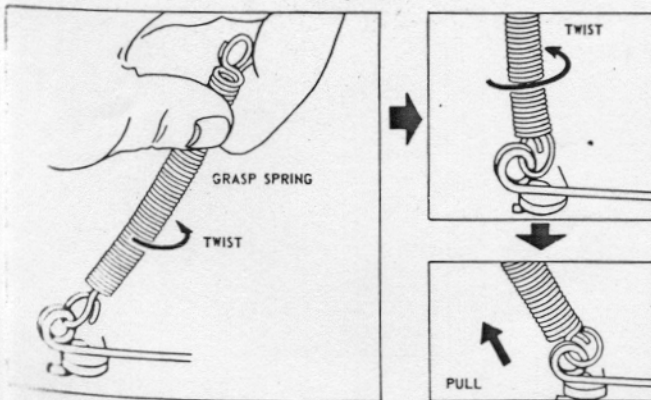

Fig. 56

INSTALLING SPRING

1 ASSEMBLE SPRING TO LINK EYELET

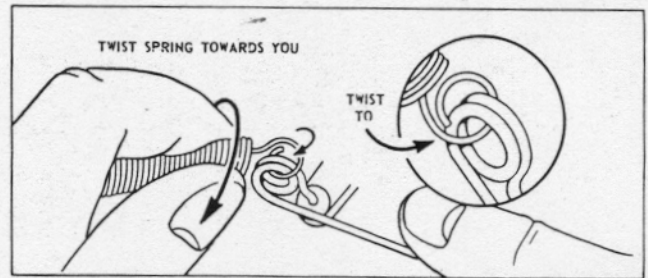
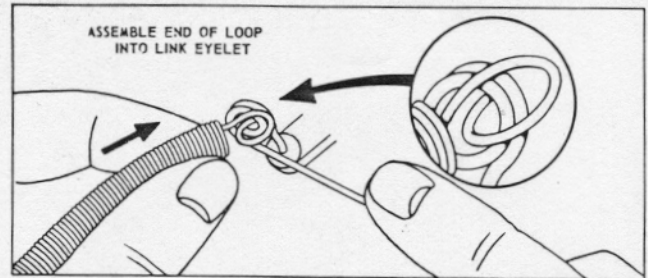
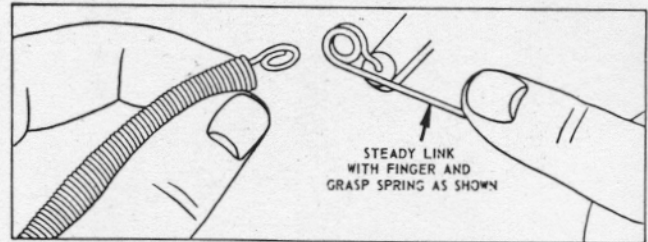

Fig. 57

2 ASSEMBLE SPRING TO CONTROL LEVER

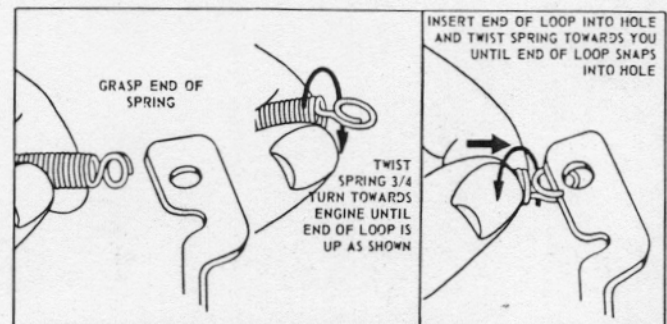

Fig. 58

# GOV. CONTROLS & CARB. LINKAGE

## Models 100000, 130000

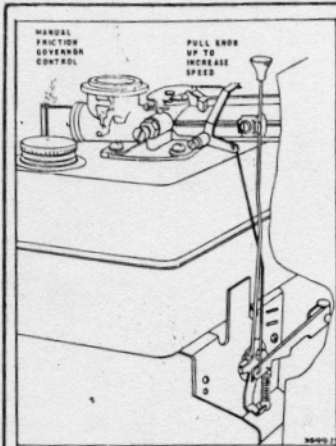

Fig. 59

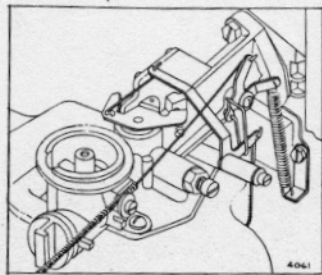

Fig. 60

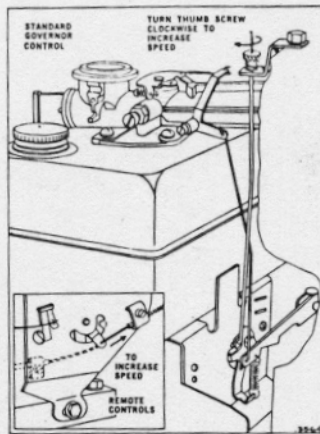

Fig. 61

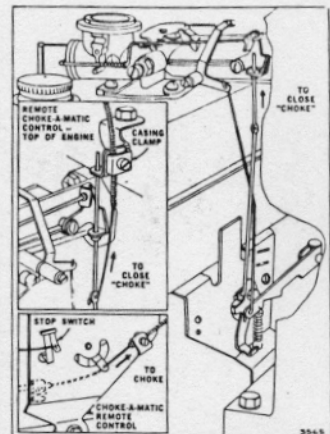

Fig. 62

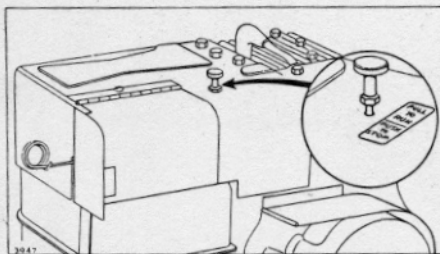

Fig. 63

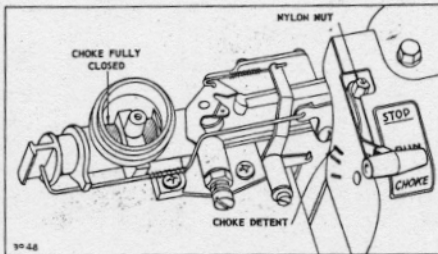

Fig. 64 - Lever-Trol  
Place lever in choke detent; if choke is not fully closed adjust nylon nut (with socket wrench) until choke just closes.

MODELS 100200, 130200

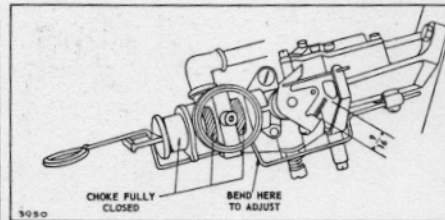

Fig. 65 - Choke Idle Return

Pull lever to choke position. The distance between throttle stamping and throttle screw stop must be 9/16". To adjust, bend lever where shown.

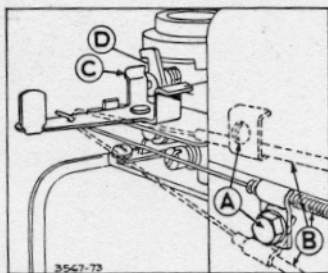

Fig. 66

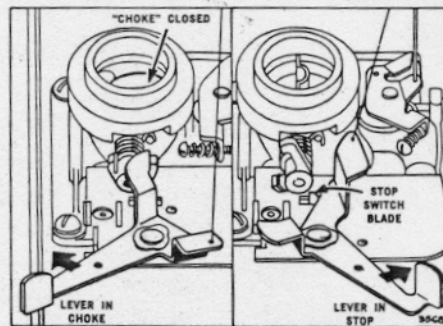

Fig. 67

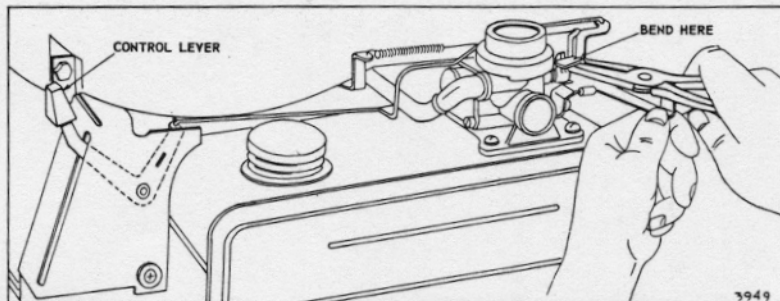

Fig. 68 - Rider-Trol

Place control in choke detent; if choke does not fully close bend as shown until choke is closed.

MODELS 100900, 130900



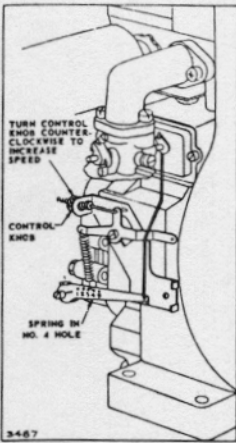

Fig. 69

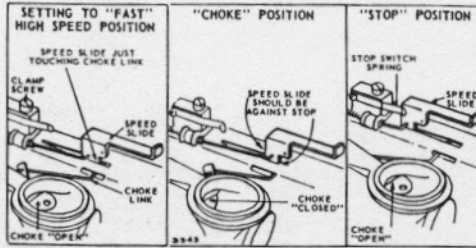

Fig. 70

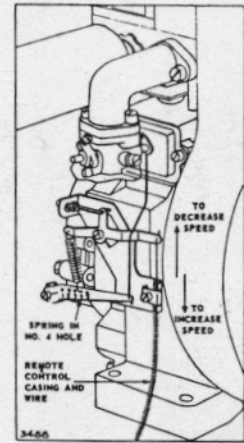

Fig. 71

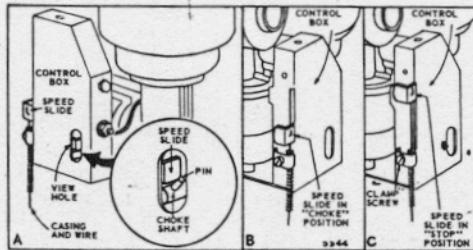

Fig. 72

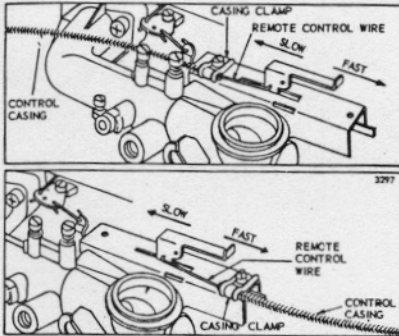

Fig. 73

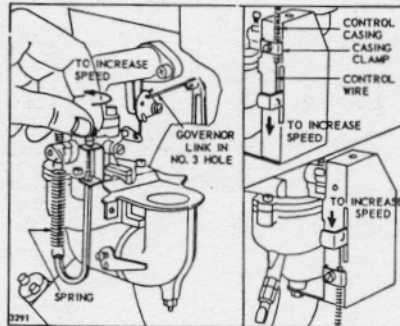

Fig. 74

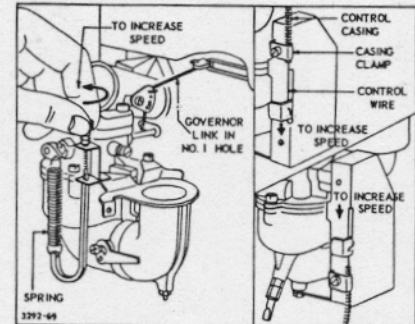

Fig. 75

MODELS 140300, 141300, 141700, 142300, 143300, 143700

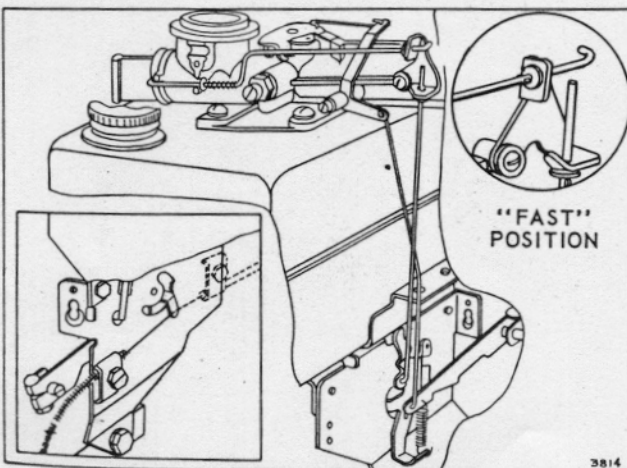

Fig. 76

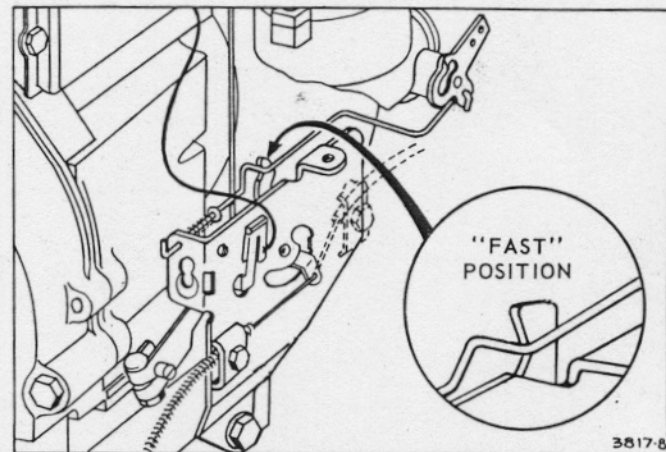

Fig. 77

ALUMINUM ENGINE MODELS 144200, 144400, 145200, 145400, 146400, 147400, 190400

# GOV. CONTROLS & CARB LINKAGE

## Models 140000, 170000, 190000

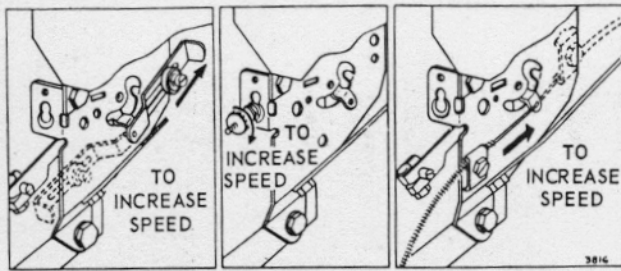

Fig. 78

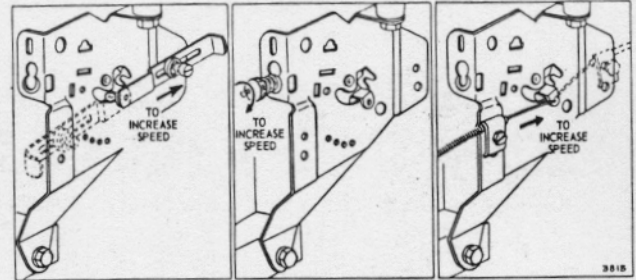

Fig. 79

### SETTING TOP SPEED - FIG. 80

TOP SPEED LIMIT SCREW POSITION	NO LOAD TOP SPEED RANGE
None	4000 to 3800 R.P.M.
No. 1 Position	3700 to 3400 R.P.M.
No. 2 Position	3300 to 3000 R.P.M.
No. 3 Position	2900 to 2500 R.P.M.
No. 4 Position	2400 to 1800 R.P.M.

Always set desired no load top speed at power test by bending end of control lever at the spring anchor. See Section 5, Fig. 16

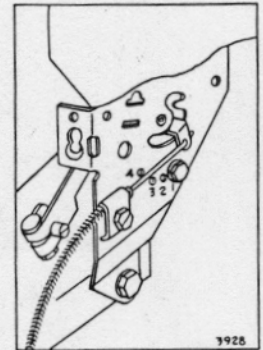

Fig. 80

Choke-A-Matic top speed range is 4000 to 3700 R.P.M. with standard spring. (Top speed limit screw cannot be used).

ALUMINUM ENGINE MODELS 144200, 144400, 145200, 145400, 146400, 147400, 190400 (Cont'd.)

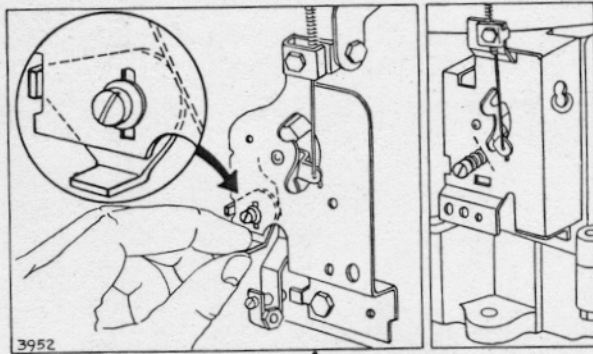

Fig. 81

### GOVERNED IDLE - FIG. 81

To adjust, first make final carburetor mixture adjustments. Then place remote control in idle position. Hold throttle shaft in closed position with fingers, adjust idle speed screw to 1550 RPM. Release throttle. Set remote control to 1750 RPM. Loosen governed idle stop and place against remote control lever. Tighten governed idle stop.

#### Adjustable Spring Loaded Screw Type

Follow above procedure, turn screw until it contacts remote control lever. See Fig. 81.

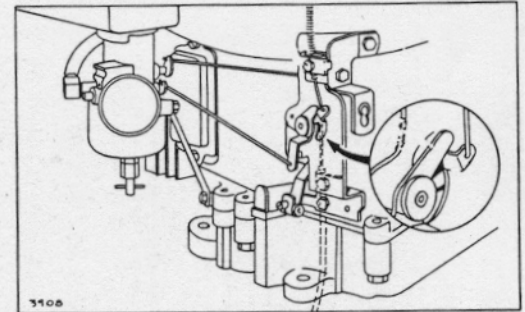

Fig. 82

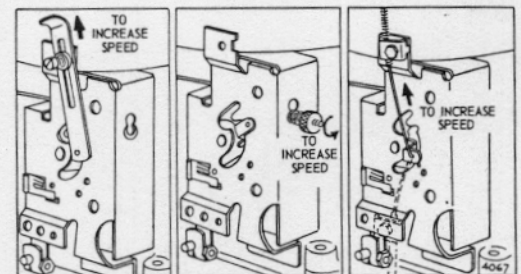

Fig. 83

ALUMINUM ENGINE MODELS 144700, 145700, 146700, 147700, 170700, 171700, 190700, 191700



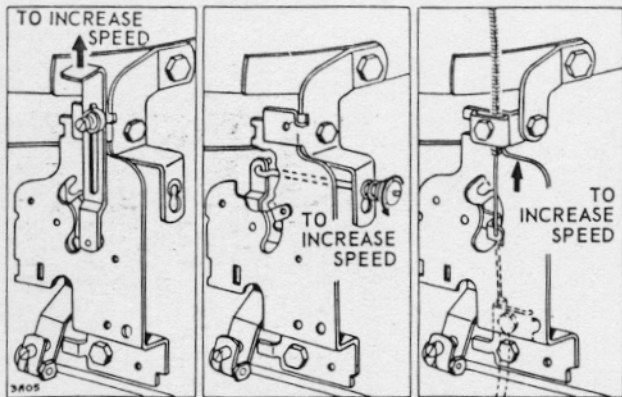

Fig. 84

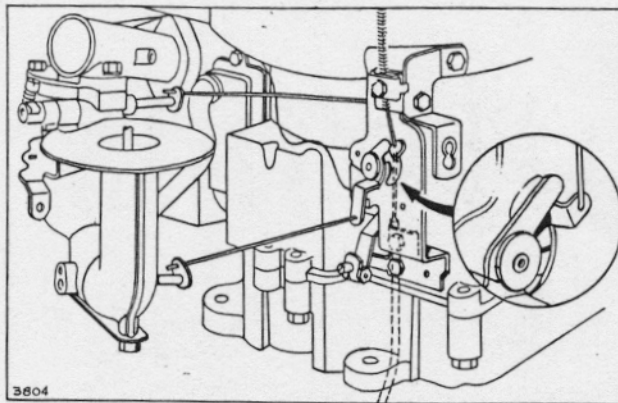

Fig. 85

SETTING TOP SPEED - FIG. 86

TOP SPEED LIMIT SCREW POSITION	NO LOAD TOP SPEED RANGE
None	4000 to 3500 R.P.M.
No. 1 Position	3400 to 2900 R.P.M.
No. 2 Position	2800 to 2400 R.P.M.

Always set desired no load top speed at power test by bending end of control lever at the spring anchor. See Section 5, Fig. 16

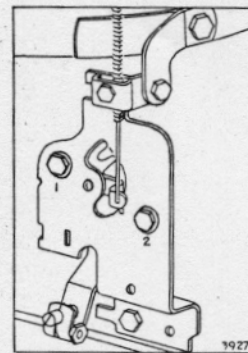

Fig. 86

Choke-A-Matic top speed range is 4000 to 3000 R.P.M. with standard spring. (Top speed limit screw cannot be used).

See Top Speed Limit Illustration, Section 5, Fig. 16

ALUMINUM ENGINE MODELS 144700, 145700, 146700, 147700, 170700, 171700, 190700, 191700 (Cont'd.)

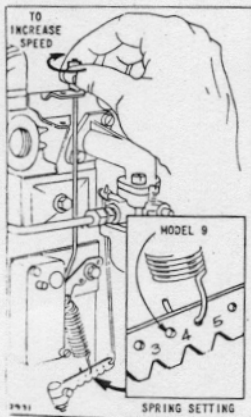

Fig. 87

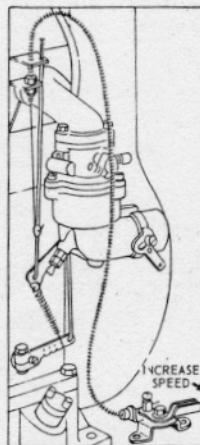

Fig. 88

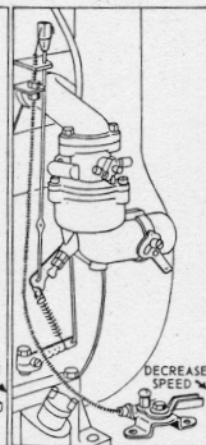

Fig. 89

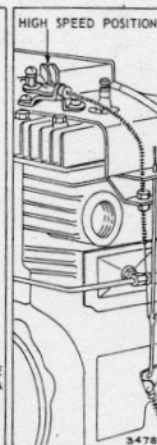

Fig. 90

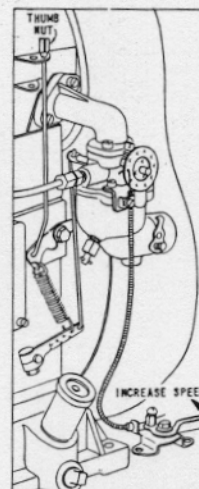

Fig. 91

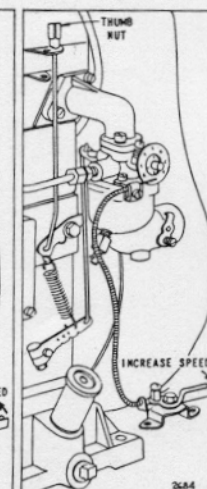

Fig. 92

CAST IRON ENGINE MODELS 9, 14, 19, 23, 190000, 200000, 230000

# GOV. CONTROLS & CARB. LINKAGE

Models 190000, 200000, 230000, 240000, 300000, 320000

## REMOTE GOVERNOR CONTROL

Attach remote control casing and wire as shown in Figure 93 or Figure 94. Do not change the position of the small elastic stop nuts. They provide for a governed idle speed and protection against overspeeding.

## THUMB NUT ADJUSTMENT

Remove thumb nut and upper elastic stop nut. Replace thumb nut and adjust to desired operating speed. See Figure 95. Do not change the position of the lower elastic stop nut. It provides protection against overspeeding.

## GOVERNED IDLE

All engines in Model Series 243400, 300400, 320400 and some Model Series 23D and 233400 engines use two governor springs as shown in Figures 96 and 97. The shorter spring keeps the engine on governor, even at idle speed. If moderate loads are applied at idle, the engine will not stall.

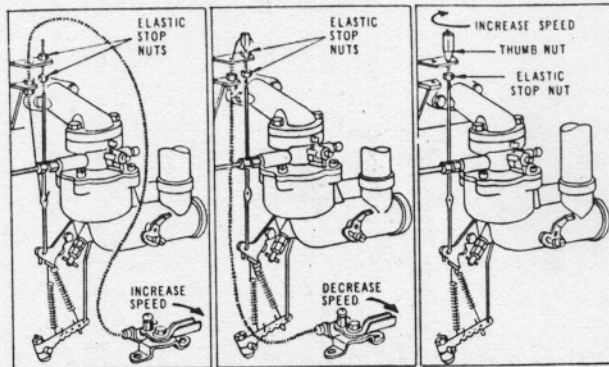

Fig. 93

Fig. 94

Fig. 95

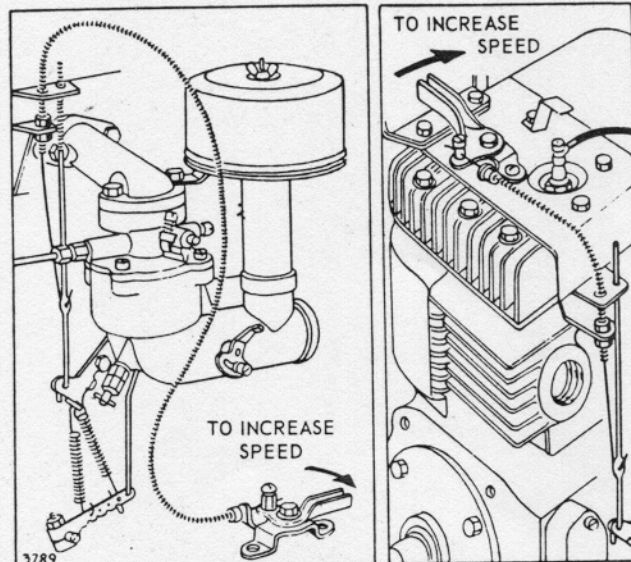

Fig. 96

## TO ADJUST FOR GOVERNED IDLE

First make final carburetor mixture adjustments. Then place remote control in idle position. Hold throttle shaft in closed position and adjust idle screw to 1000 R.P.M. Release the throttle. With remote control in idle position, adjust upper elastic stop nut to 1200 R.P.M. See Fig. 97.

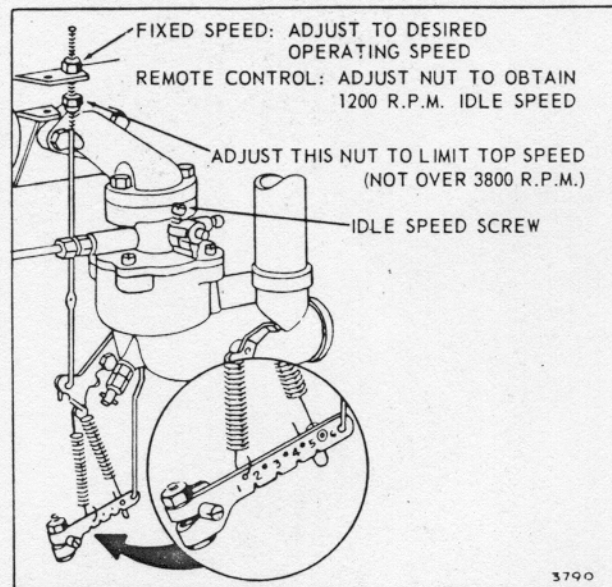

Fig. 97

MODELS 190000, 200000, 230000, 240000, 300000, 320000