

OPERATOR'S MANUAL

**ECHO
CHAIN SAW
CS-650EVL**

CAUTION

Read Rules for Safe Operation
and Instructions Carefully



RULES FOR SAFE OPERATION

1. Never operate a chain saw when you are fatigued.
2. Use safety footwear, snug-fitting clothing, protective gloves and eye, hearing and head protection devices.
3. Always use caution when handling fuel. Move the chain saw at least ten (10) feet, or three (3) meters from the fueling point before starting the engine.
4. Do not allow other persons to be near the chain saw when starting or cutting. Keep bystanders and animals out of the work area.
5. Do not start cutting unit you have a clear work area, secure footing, and a planned retreat path from the falling tree.
6. Always hold the chain saw firmly with both hands when the engine is running. Use a firm grip with thumb and fingers encircling the chain saw handles.
7. Keep all parts of your body away from the saw chain when the engine is running.
8. Before you start the engine, make sure the saw chain is not contacting anything.
9. Always carry the chain saw with the engine stopped, the guide bar and saw chain to the rear, and the muffler away from your body.
10. Never operate a chain saw that is damaged, improperly adjusted, or is not completely and securely assembled. Be sure that the saw chain stops moving when the throttle control trigger is released.
11. Always shut off the engine before setting it down.
12. Use extreme caution when cutting small size brush and saplings because slender material may catch the saw chain and be whipped toward you or pull you off balance.
13. When cutting a limb that is under tension, be alert for spring back so that you will not be struck when the tension in the wood fibers is released.
14. Keep the handles dry, clean and free of oil or fuel mixture.
15. Spark arrester mufflers approved to SAE Standard J335b are available for all ECHO chain saws to reduce the possibility of forest fires. Do not operate the chain saw with a loose or defective muffler. Do not remove the spark arrester screen.
16. Operate the chain saw only in well ventilated areas.
17. Do not operate a chain saw in a tree unless specially trained to do so.
18. All chain saw service, other than the items listed in the Operator's Manual should be performed by competent chain saw service personnel. (For example, if improper tools are used to remove the flywheel, or if an improper tool is used to hold the flywheel in order to remove the clutch, structural damage to the flywheel could occur which could subsequently cause the flywheel to burst.)
19. Guard against kickback. Kickback is the upward motion of the guide bar which occurs when the saw chain at the nose of the guide bar contacts an object. Kickback can lead to dangerous loss of control of the chain saw.
TO AVOID KICKBACK:
 - Hold the chain saw firmly with both hands. Don't overreach.
 - Don't let the nose of the guide bar contact a log, branch, ground or any other obstruction.
 - Cut at high engine speeds.
 - Don't cut above shoulder height.
 - Follow manufacturer's sharpening and maintenance instructions for the saw chain.
 - Use devices such as low kickback chain, which may help to reduce the hazards associated with kickback.
20. When transporting your chain saw, use appropriate guide bar scabbard.

FRONT HANDLE and HAND GUARD INSTALLATION

Install the front handle and hand guard before installing the guide bar and saw chain, in numerical order as shown.

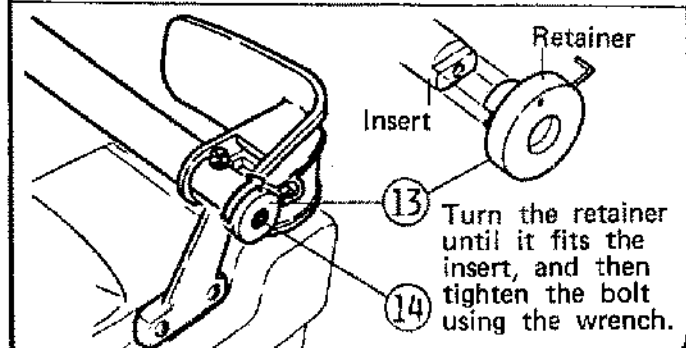
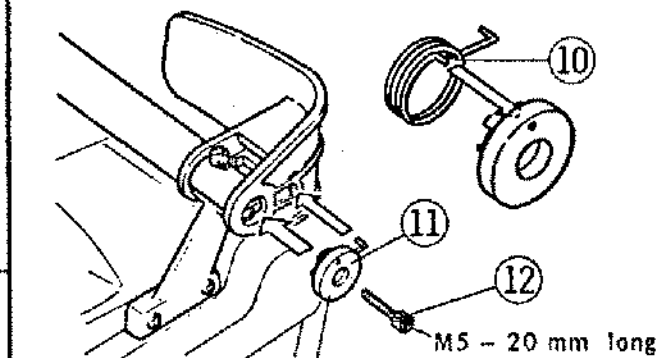
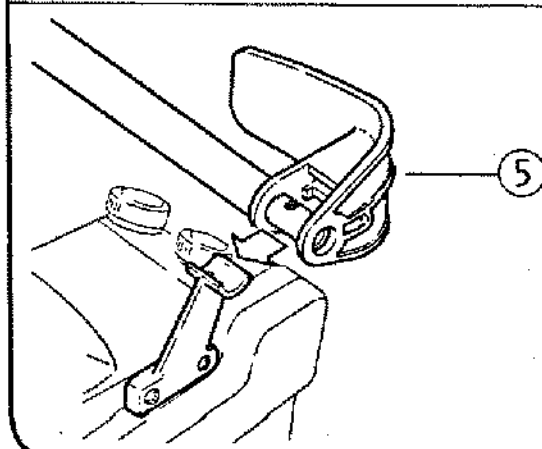
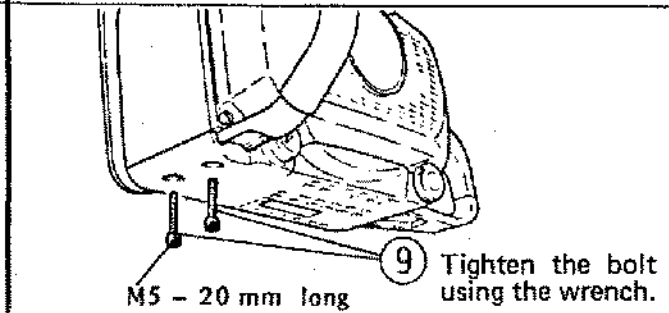
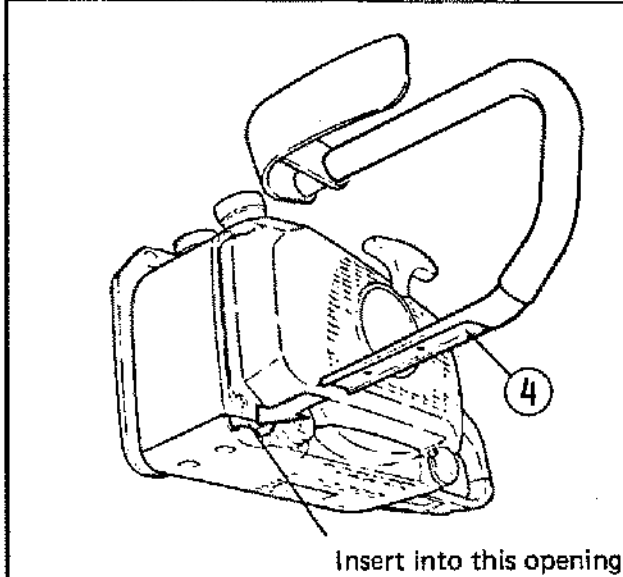
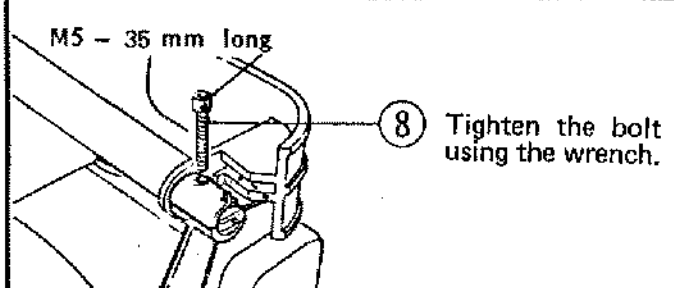
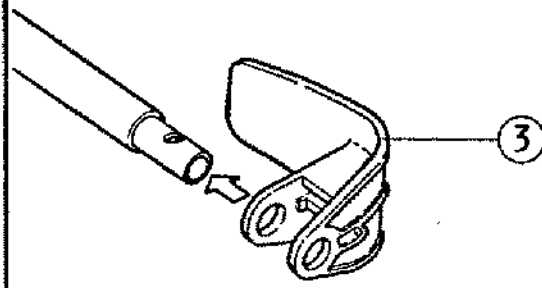
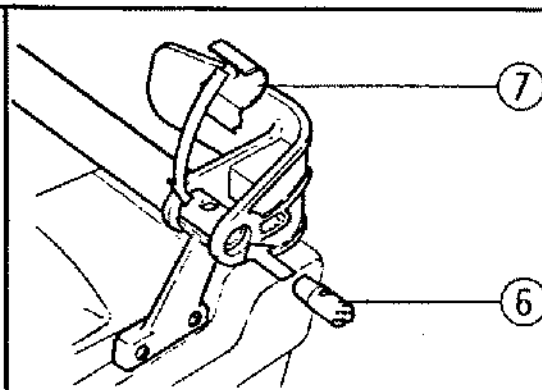
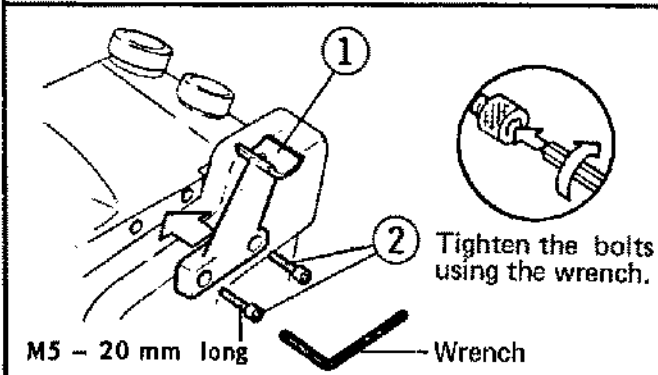

CONTENTS

	Page
Rules for Safe Operation	1
Technical Data	3
Nomenclature of Parts	4
Preparation for Use	4
Operation	5
Method of Cutting	8
Maintenance and Care	9
Setting the Chain	11
Chain Brake (Optional)	12
Trouble Shooting	14
Storage	15
Parts Catalogue	18

TECHNICAL DATA

Dimension:	L x W x H (mm)	413 x 257 x 267 (16.3" x 10.1" x 10.5")
Weight:	Power Head, dry (kg)	6.4 (w/o chain and guide bar): (14.1 lbs)
Engine:	Type Displacement (cc) Carburetor Magneto Spark plug Starter Power transmission	Air cooled 2-cycle single cylinder 64.2 (3.86 cu.in.) Walbro diaphragm type HDB Flywheel magneto, TCI (Transistor Control Ignition) system NGK BPM7A Recoil starter Automatic centrifugal clutch
Fuel:	Mixture ratio Tank capacity (l)	Mixture of regular grade gasoline and air cooled two stroke engine oil [20:1 Ratio or 32:1 Ratio with special oil approved by ECHO] 0.65 (21.9 Fl.oz.US)
Oil:	Chain oil Tank capacity (l)	Motor oil 0.30 (10.1 Fl.oz.US)
Guide bar and chain:	Lubrication Chain pitch Gauge Number of drive link Guide bar type Guide bar gauge	Automatic 3/8" .050" 60 16B50 .050"
Other devices:		Front hand guard Rear hand guard Throttle control lockout Chain catcher Anti-vibration device Spike bumper Chain brake (Optional) Spark arrester muffler

Technical data may be changed without advance notice.

NOMENCLATURE OF PARTS

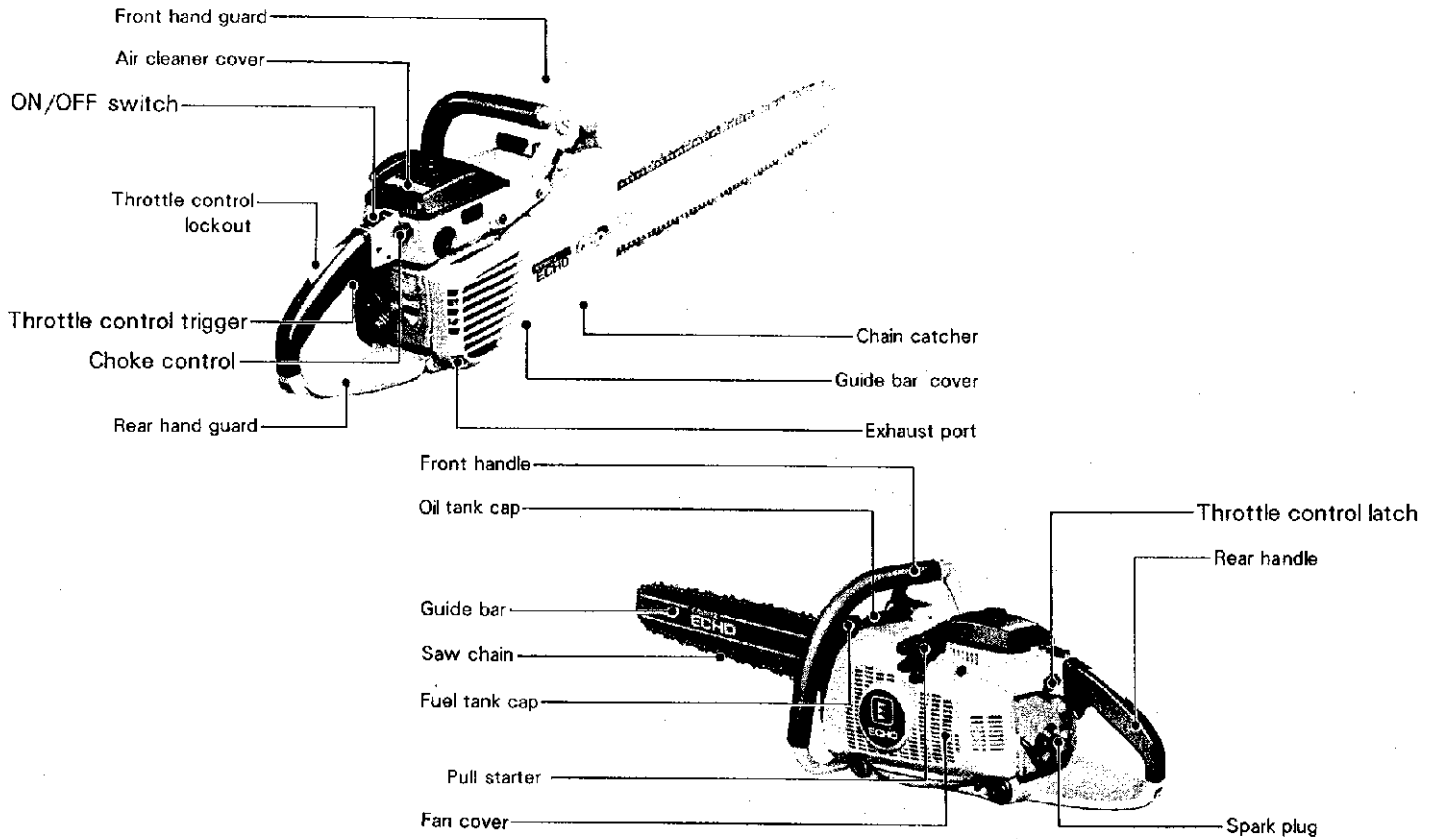

PREPARATION FOR USE

MOUNTING GUIDE BAR AND CHAIN

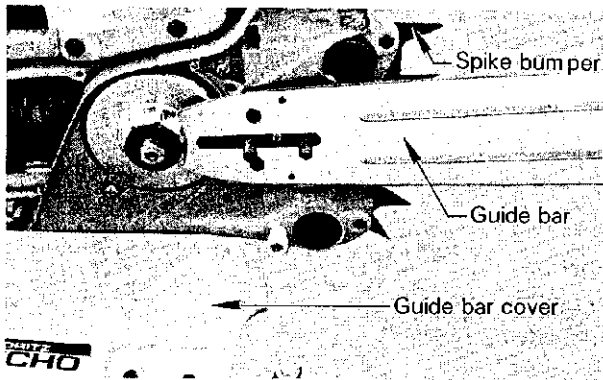

- Attach spike bumper to the machine and tighten both hexagon socket bolts, before installing guide bar.
- Unscrew two nuts and remove guide bar cover.
- Mount bar and slide toward sprocket to make saw chain installation easier.

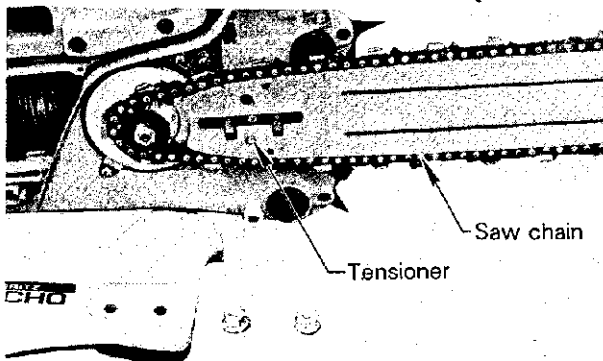

- Install chain as shown with cutters facing forward.
- Ensure that tensioner fits into bar slot.
- Install guide bar cover, tighten nuts finger tight.

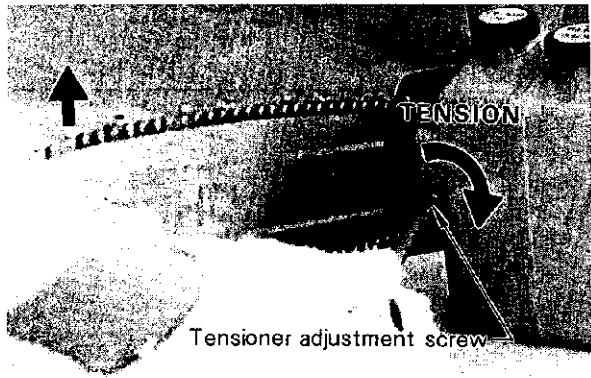

ADJUSTMENT, CHAIN TENSION

- Turn the adjuster screw clockwise until the chain touches the bottom of the bar.
- Hold the bar nose up and tighten the chain until there is no clearance between the bar and chain tie straps.
- Tighten both nuts with the bar nose held up to eliminate clearance.
- Pull the chain around the bar by hand. Loosen the adjustment if you feel tight spots.
- Start the engine and run at low speed. Stop and readjust if necessary.

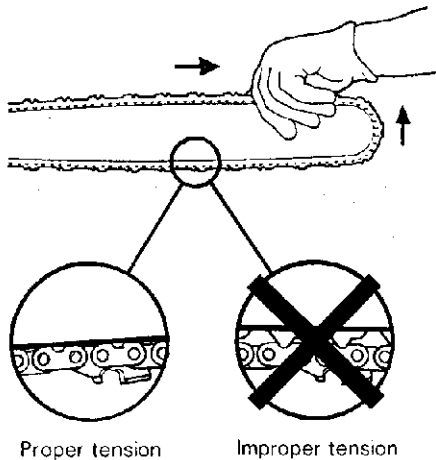

CAUTION

1. All adjustments should be made cold.
2. Always wear gloves when working on chain.
3. Do not operate with a loose chain

OPERATION

CHECK FOR LOOSE NUTS AND SCREWS

Check for loose nuts and screws on the handle, fan cover, etc. each time before using the chain saw.

FUEL AND LUBRICANT

- Fuel is a mixture of regular grade gasoline and ECHO brand motor oil (or an air cooled 2-cycle engine oil of a reputable brand name).

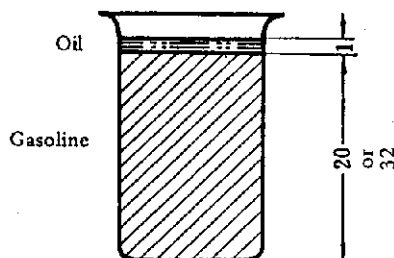

- Mixture ratio is:
Gasoline 20 parts: Oil 1 part.

— Fuel mixture at a ratio other than 20:1 may cause malfunction of the engine. Ensure mixture ratio is correct.

[NOTE]

32:1 Ratio is applicable with special oil approved by ECHO.

- Pour 1/2 of the gasoline into a safe container, add the oil and mix thoroughly. Now add the remainder of gasoline and mix again.
- Disregard instruction on oil container.
- Do not use motor oil other than recommended above.
- Do not mix directly in engine fuel tank.
- Avoid spilling fuel or oil. Spilled fuel should always be wiped up.

- Fuel Mix Chart

20:1

(US)		(METRIC)	
GAS	OIL	GAS	OIL
Gal.	Fl.oz.	Liter	cc.
1	6.4	4	200
2	12.8	8	400
5	32.0	20	1000

32:1

(US)		(METRIC)	
GAS	OIL	GAS	OIL
Gal.	Fl.oz.	Liter	cc.
1	4	4	125
2	8	8	250
5	20	20	625

- Chain Lubricant

Proper lubrication of the chain while in operation reduces the friction between the chain and the guide bar to a minimum and assure a longer service life. Use motor oil of proper quality for this purpose.

- Do not use waste or reclaimed oil to avoid various oiler problems.
- Use motor oil of the following grades:
 - SAE NO. 30 in summer
 - SAE NO. 10 in winter or when cutting resinous trees
- When refueling, also refill chain oil.

STARTING THE ENGINE

- WHEN THE ENGINE IS COLD

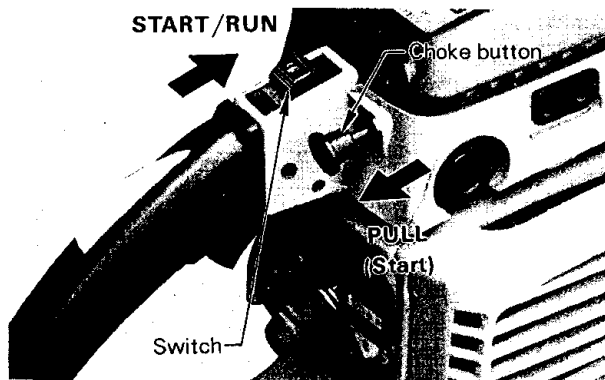

- Fill the fuel tank with fuel.
- Fill the chain oil tank with lubricant.
- Slide stop switch forward.
- Pull choke all the way out.

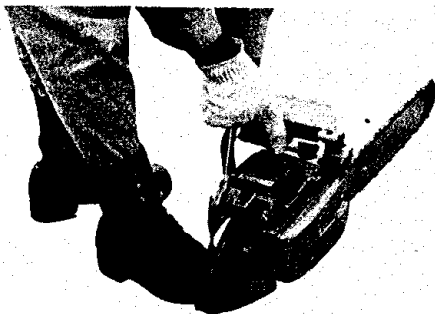

Securely hold the saw

- Securely hold the saw as shown and pull starter handle several times until first firing sound.
- Make sure bar and chain are not touching anything when starting the saw.

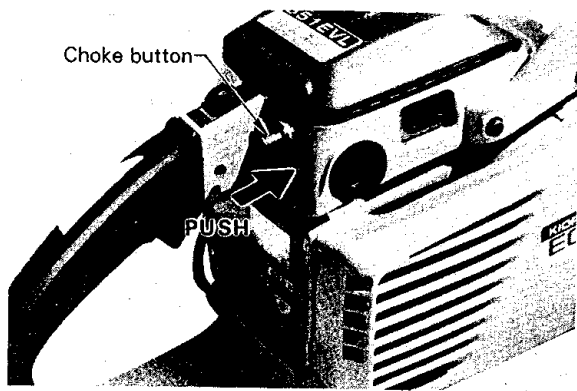

- Push choke all the way in.
- Pull starter handle again.

WHEN THE ENGINE IS HARD TO START

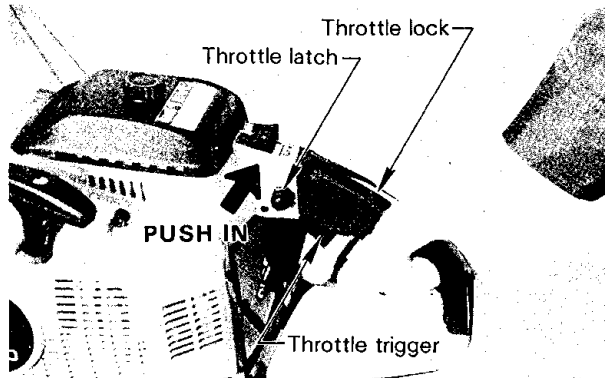

- Press lock down while holding throttle trigger and push in latch as shown.
- Pull starter handle.
- When engine starts, immediately squeeze throttle trigger up, to release the latch.

[CAUTION]

Clutch engages and chain will rotate when engine is started with throttle latch engaged. After engine starts, release throttle trigger to idle engine. Never use the throttle latch for cutting. Use it only when starting the engine.

WHEN THE ENGINE IS WARM



- Ensure that there is fuel and chain oil in the tanks.
- Slide stop switch to front.
- Pull starter handle.
- Choke may be used if necessary but be sure to push it back on first firing sound.

RUNNING AND STOPPING THE ENGINE

RUNNING

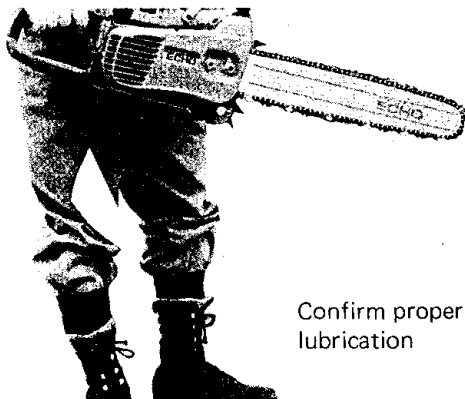

- After engine starts, allow it to idle for a few minutes.
- Squeeze throttle trigger gradually to increase engine revolution.
- The chain starts running when the engine reaches 3,000 rpm approximately.
- Ensure proper acceleration and lubrication of chain and bar.
- Do not run the engine at high speed unnecessarily.

STOPPING

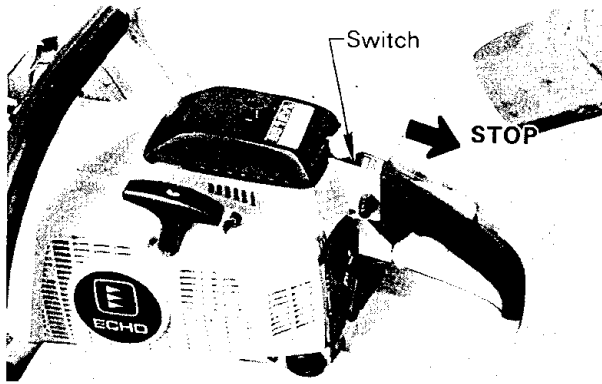

- Release throttle trigger and slide stop switch back.

[NOTE]

When engine does not stop, pull choke all the way out to stop engine.
Check and repair stop switch before starting the engine again.

METHOD OF CUTTING

- Read carefully the "RULES FOR SAFE OPERATION" on page 1.
- Familiarize yourself with your chain saw before you start actual cutting.
- For this purpose, it may be wise to practice by cutting some small logs or limbs several times.
- After you have learned the basic techniques of using the saw, your best aid will be your own good common sense.
- Racing the engine with the chain jammed will burn out your clutch. If the chain should become jammed and the saw can not be removed from the cut, do not force it out. Stop the saw and force a wedge into the cut to open it up. Never force the saw when it is jammed.
- Do not force the saw into the cut. It will cut through a log surprisingly fast by applying only light pressure. If you find you have to bear down on the saw to cut, your chain is dull. Have it sharpened before continuing. A dull chain is unsafe and will cause excessive wear to the cutting attachments. A good way to tell when the chain is dull is when fine saw dust comes out instead of chips.
- Wear safety shoes, snug-fitting clothing, goggles and ear and head protection devices.

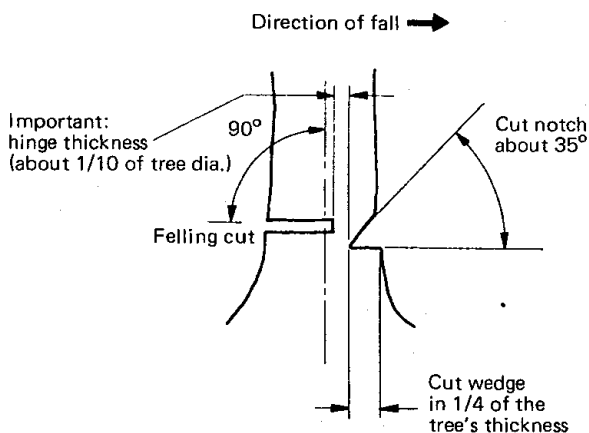

- Before felling a tree.
 - Check the wind.
 - Check the lean. If possible, fell it in the direction it leans.
 - Check the weight distribution.
- When the direction has been decided, completely clear the area around the tree and establish a good foothold.
- Decide on a path of retreat.
- Cut a notch one-quarter of the way into the tree on the side that is to fall, and as close to the ground as possible.
- Then make a felling cut from the opposite side of the notch and at a level slightly higher than the notch.

LUMBERING

- Before lumbering, stabilize the felled tree. A tree on a slope may roll down as you limb it.
- Keep the tree off the ground by using a support, so that the chain or bar will not be pinched.
- Some material may adversely affect the housings of your Echo chain saw. (Example palm tree Acid, fertilizer etc.) To avoid housing deterioration, carefully remove all packed saw dust around clutch and guide bar area and wash with water."

MAINTENANCE AND CARE

CARBURETOR

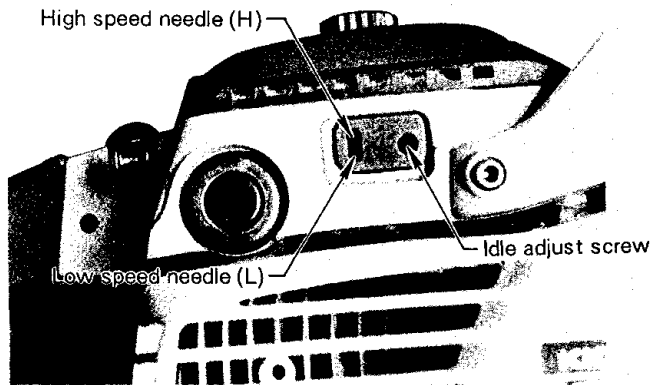

- Do not adjust the carburetor unless necessary.
- To adjust the carburetor, proceed as follows:
 - Low speed needle: (L) $1-1/8 \pm 1/4$
 - High speed needle: (H) $1 \pm 1/4$
 - Screw in the needles until lightly seated and return indicated turn above.
- Turn idle adjust screw clockwise until chain begins to turn, then back screw $1/2$ turn.

[CAUTION]

Always open high speed needle MORE THAN $3/4$ turn, and open low speed needle LESS THAN $1-3/8$ turn.

AIR FILTER

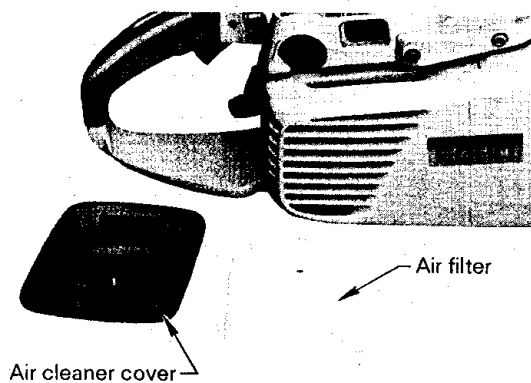

- Check before every use.
- Loosen thumb bolt, and remove air cleaner cover and filter.
- Brush off dust lightly, or wash it in gasoline if necessary. Dry it completely before installation.

FUEL STRAINER

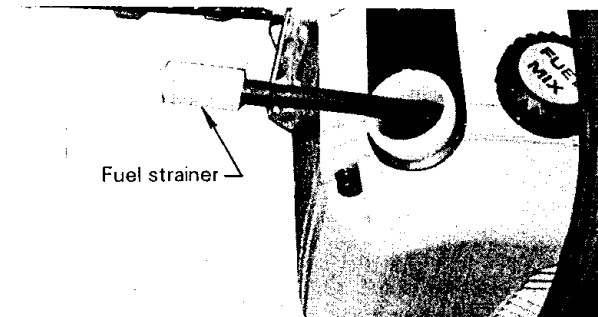

- Check periodically.
 - Do not allow dust to enter fuel tank.
 - Clogged strainer will cause difficulty in starting engine or abnormalities in engine performance.
 - Pick up the fuel strainer through fuel inlet port with a piece of steel wire of the like.
 - When the strainer is dirty, wash it in gasoline.
 - When the inside of the fuel tank is dirty, it can be cleaned by rinsing the tank out with gasoline.

GUIDE BAR

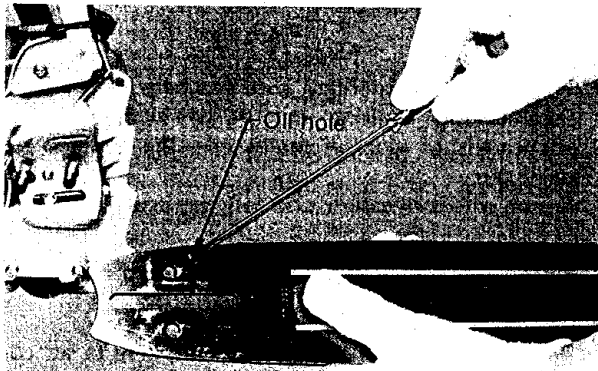

- Clean before using.
 - Clean the groove of the guide bar with, for example, a small screw driver.
 - Clean oil holes with a wire.
- Reverse guide bar periodically.
- Clean sprocket, clutch and bar mount area before installing.

SPROCKET

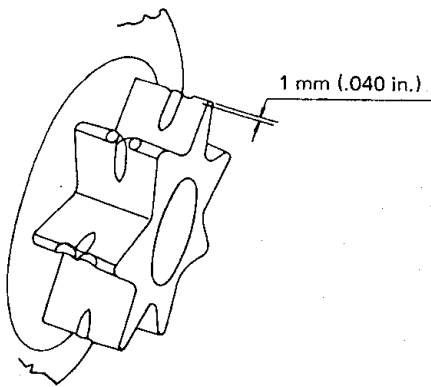

- The damaged sprocket will cause premature damage or wear of saw chain.
 - When the sprocket has worn out 1.0 mm (.040 in.) or more, replace it.
- Check sprocket when you install new chain. Replace it if worn.

AUTOMATIC OILER

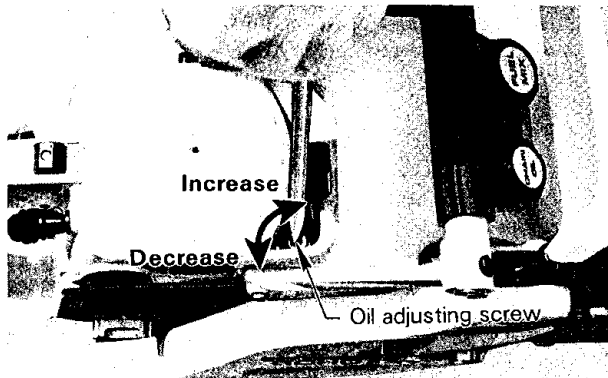

- The discharge volume of the automatic oiler is adjusted to 8–12 cc/min. approx. at 8000 rpm, prior to shipment from factory.
 - To increase the delivery volume, turn the adjusting screw clockwise. When the screw touches stopper and stops, this position indicates maximum discharge volume. (20–25 cc/min. 8000 rpm)
 - Do not turn the adjusting screw beyond the max. or min. limit of volume adjustment.

OIL STRAINER

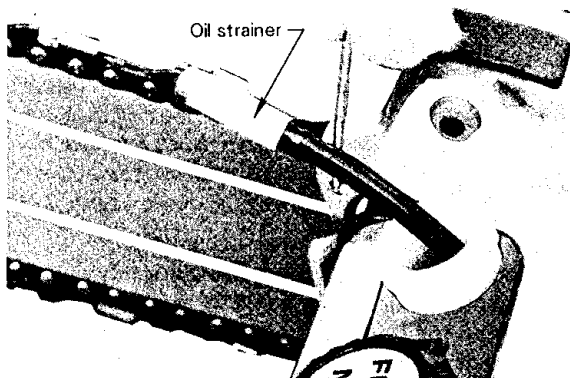

- Check periodically.
 - Do not allow dust to enter into oil tank.
 - Clogged oil strainer will affect the normal lubricating system.
 - Pick it up through oil filling hole with a piece of steel wire or the like.
 - If the strainer is dirty, wash it in gasoline.
 - When the inside of the tank gets dirty, it can be cleaned by rinsing the tank out with gasoline.

SPARK PLUG

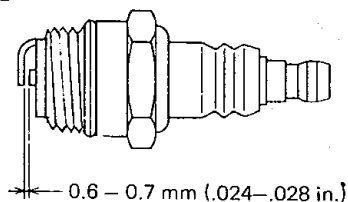

- Check periodically.
 - The standard spark gap is 0.6–0.7 mm (.024–.028 in.).
 - Correct the spark gap if it is wider or narrower than the standard gap.
- Fastening torque = 145–155 kg·cm (125–135 in·lb).

MAGNETO

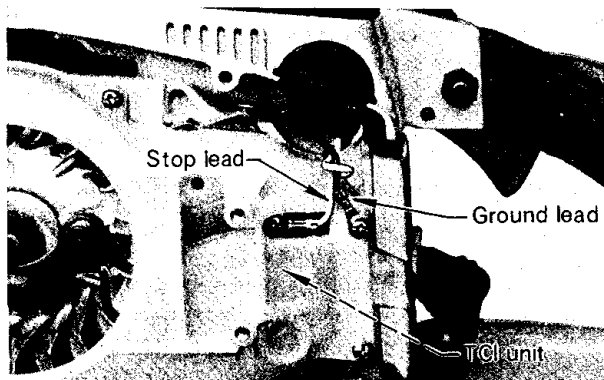

- The unit is incorporated with magneto of T.C.I. (Transistor Control Ignition) system, which does not require adjustment of ignition timing and the contact breaker point gap.
- Ensure wire connections and couplers assembling.

CYLINDER FINS

- Check periodically.
- Clogged fins will result in poor engine cooling.
- Remove dirt and dust from between fins to let cooling air pass easily.

SETTING THE CHAIN (For the Oregon 72DP type chain)

NOMENCLATURE OF PARTS

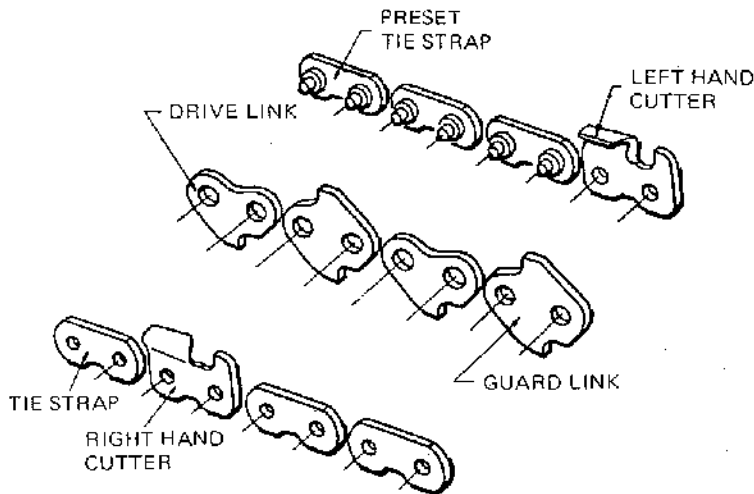

- Guard links reduce the potential of kickback.

CUTTER PART NAMES

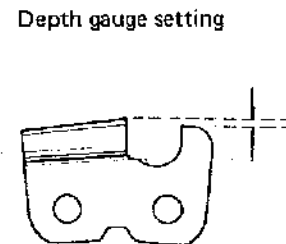
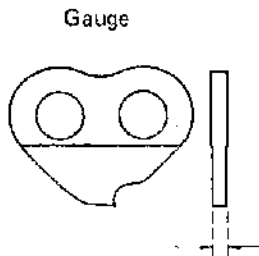
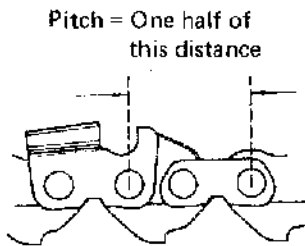
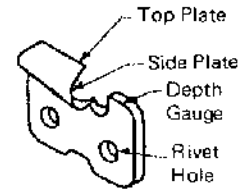

- Gauge is thickness of drive links.
- Depth gauge controls the cutting depth.

Important points for proper maintenance of saw chain:

- Keep the cutters sharp at all times.
- Keep the left and the right cutters properly aligned.
 - Please note that blunt or irregular cutters will result in poor cutting performance, increased vibration of chains and premature breakage of the saw chain.
- Drive link serves to remove sawdust from the groove of the guide bar. Therefore, keep the lower edge of the drive link, indicated by the arrow, sharp.

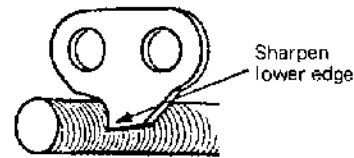
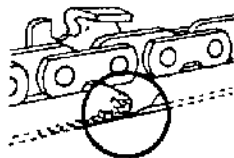

- When setting of the chain is finished, soak it in oil and wash away filings completely before using.
- When chain has been filed on the bar, supply sufficient oil to it, rotate the chain slowly to wash away the filings before using again.
- If the chain saw is operated with filings clogged in the groove, the saw chain and the guide bar will be damaged prematurely.
- If the saw chain becomes soiled with resin, for instance, clean it with kerosene and soak it in oil.

For setting saw chains, round file (5.5 mmφ: 7/32") and flat file are used.

- To keep correct position and correct angle, use the file holder (Sure Sharp).
 - Round file (P-No. 897510-00230) and flat file (P-No. 897511-00230) are optional.
 - Please inquire about the file holder, if desired.

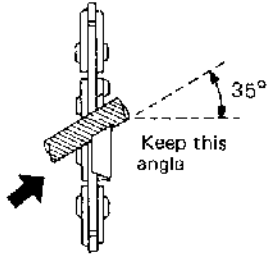

PUSH FILE AS SHOWN

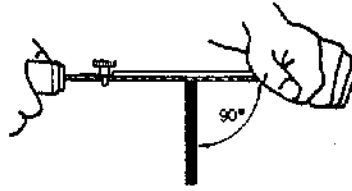

HOLD FILE HOLDER LEVEL.

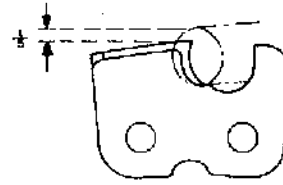

ONE FIFTH OF FILE DIAMETER REMAINS ABOVE CUTTER EDGE

- Place the depth gauge tool firmly on guide bar so that depth gauge protrudes. Then file top of depth gauge with flat file until flat with top of the depth gauge tool.
 - Be sure to round off the front edge of the depth gauge.

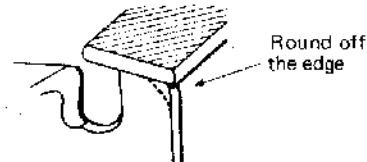
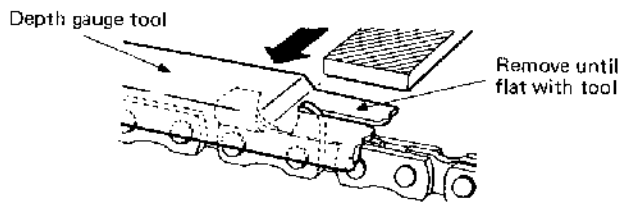

- Properly filed cutters are shown below.

(Top plate angle)

(Side plate angle)

(Top plate cutting angle)

(Depth gauge)

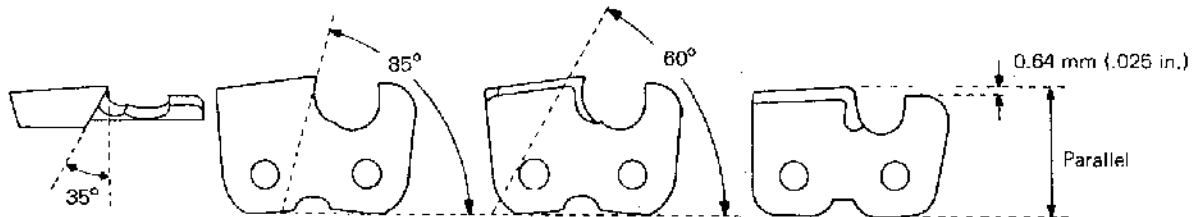

[NOTE]

These angles are referred to as Oregon 76LG.

To sharpen other follow chain manufacturer's instruction.

CHAIN BRAKE – OPTIONAL (Part No. 433 100-1433 0)

INSTALLATION – ADJUSTMENT – MAINTENANCE

The installation of a chain brake may be mandatory by law or as stipulated by insurance regulations in your area of operation. You should enquire through local government offices, your employer or your local dealer to ensure that your chain saw conforms to the required safety standard. Echo chain brakes have been designed and tested to comply with international safety standards as follows.

USA: ANSI Standard B 175.1 Safety Requirement for chain saws

Canada: CSA Standard Z 62.1 CANADA

WARNING:

- ANSI Standard B175.1 stipulates that the brake shall stop the chain in 0.10 seconds (one tenth) at an engine speed of 8000 RPM. It is the responsibility of the Owner/Operator to ensure that the brake is serviced, adjusted and tested strictly in accordance with the instructions as detailed herein in order to ensure that the brake performance is maintained in compliance with the Standard B 175.1.

INSTALLATION

- Echo recommends that the chain brake should be serviced by an authorized Echo servicing dealer. Detailed instructions are included in every kit.

OPERATION

The chain brake is engaged when the lever is in the forward position. The chain brake is disengaged when the lever is in the center position.

NOTE

The third position of the lever does not affect the brake and is intended only to provide better access to the fuel & oil caps.

- Set the lever in the center position before starting to cut.
- If the brake is tripped by kick back reaction, the chain will stop. Immediately release the throttle to avoid possible damage to the engine or clutch.
- Do not attempt to start or operate the engine with the brake engaged.

MAINTENANCE

- Remove the guide bar cover.
- Remove the plastic cover over the brake.
- Clean oil and saw dust from complete chain brake area.
- Examine the drum, brake band and linkage for any indication of wear.

ADJUSTMENT

- Loosen the screw (H) securing the adjusting cam (G).
- Rotate the cam counter clockwise to tighten the brake band. The band should not contact the drum.
- Tighten the securing screw (H) and again ensure that the band does not touch the drum.
- Check that the brake lever is spring locked firmly in each position.
If the lever will not move fully forward into the BRAKE ON position, readjust the band to provide more clearance.

WARNING: KICKBACK IS DANGEROUS

- Kickback is generated when the forward movement of the chain is arrested for some reason. The most dangerous effect of this action occurs when the nose of the bar contacts another object, the chain is momentarily stopped and all the energy of engine throws the bar upwards and backwards towards the operator.
- The chain saw industry and government agencies have attempted to prescribe various safety devices, but the best protection is to avoid kickback.
- Comply with the Safety Precautions as listed on pages 1 and 2 of this manual.

TESTING THE BRAKE

- Start the engine on a solid level surface and run at a fast idle until warm.
- Hold the saw firmly by the handles and accelerate the engine to a fast idle.
- Slowly operate the chain brake lever while holding the saw firmly on the ground. When the brake lever trips, the chain should stop. Immediately release the throttle trigger.

CAUTION

DO NOT ALLOW THE SAW TO TIP FORWARD IN ORDER TO AVOID DAMAGE TO THE CHAIN.

If the chain does not stop immediately return the saw to your authorized Echo dealer for repair.

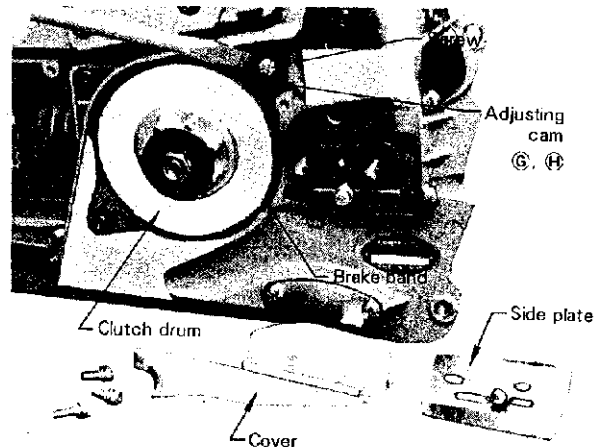

KICKBACK

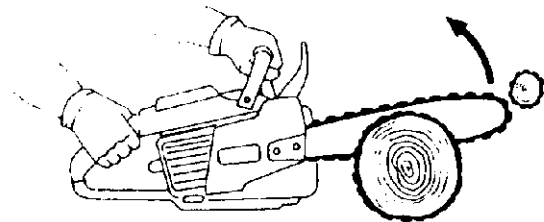

CHAIN BRAKE ENGAGED

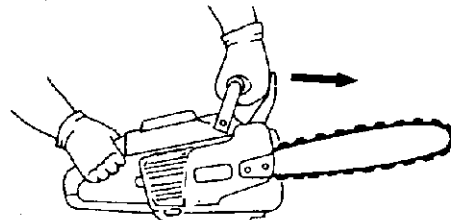

TROUBLE SHOOTING

Poor performance of the engine and/or cutting mechanism can normally be prevented by carefully following the above instructions.

Poor performances can easily be corrected even by a beginner.

When the engine does not function properly check the following three (3) points first.

- Is engine compression adequate?
- Is fuel system in good condition and is enough fuel being supplied?
- Is electrical system in good condition and is spark plug operating normally?

When there is serious trouble with the unit, do not try to repair it yourself but have your distributor or dealer do it for you. For detailed **TROUBLE SHOOTING** refer to tables 1 and 2. Locate the problem on the following charts and repair as necessary.

Table 1

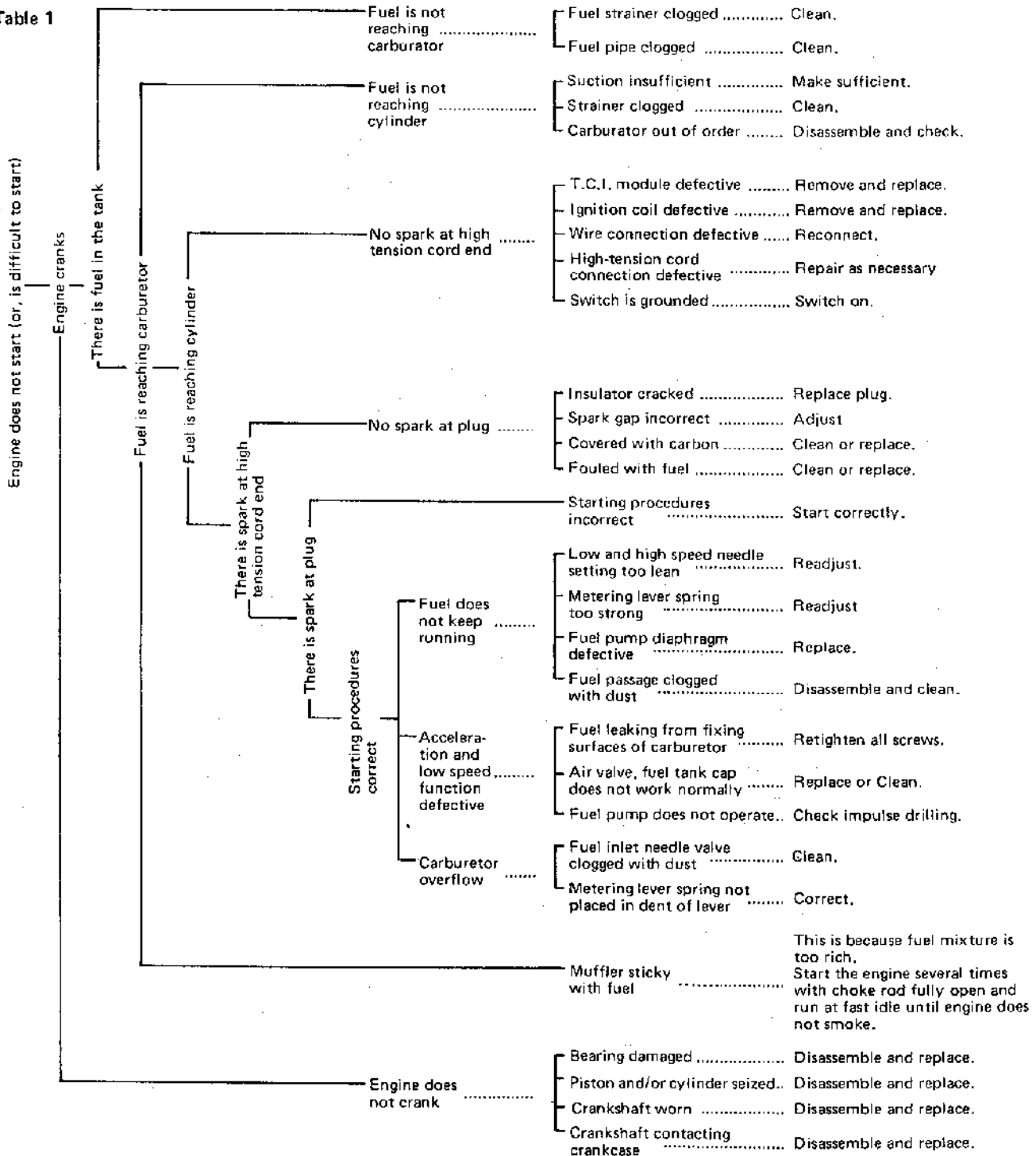
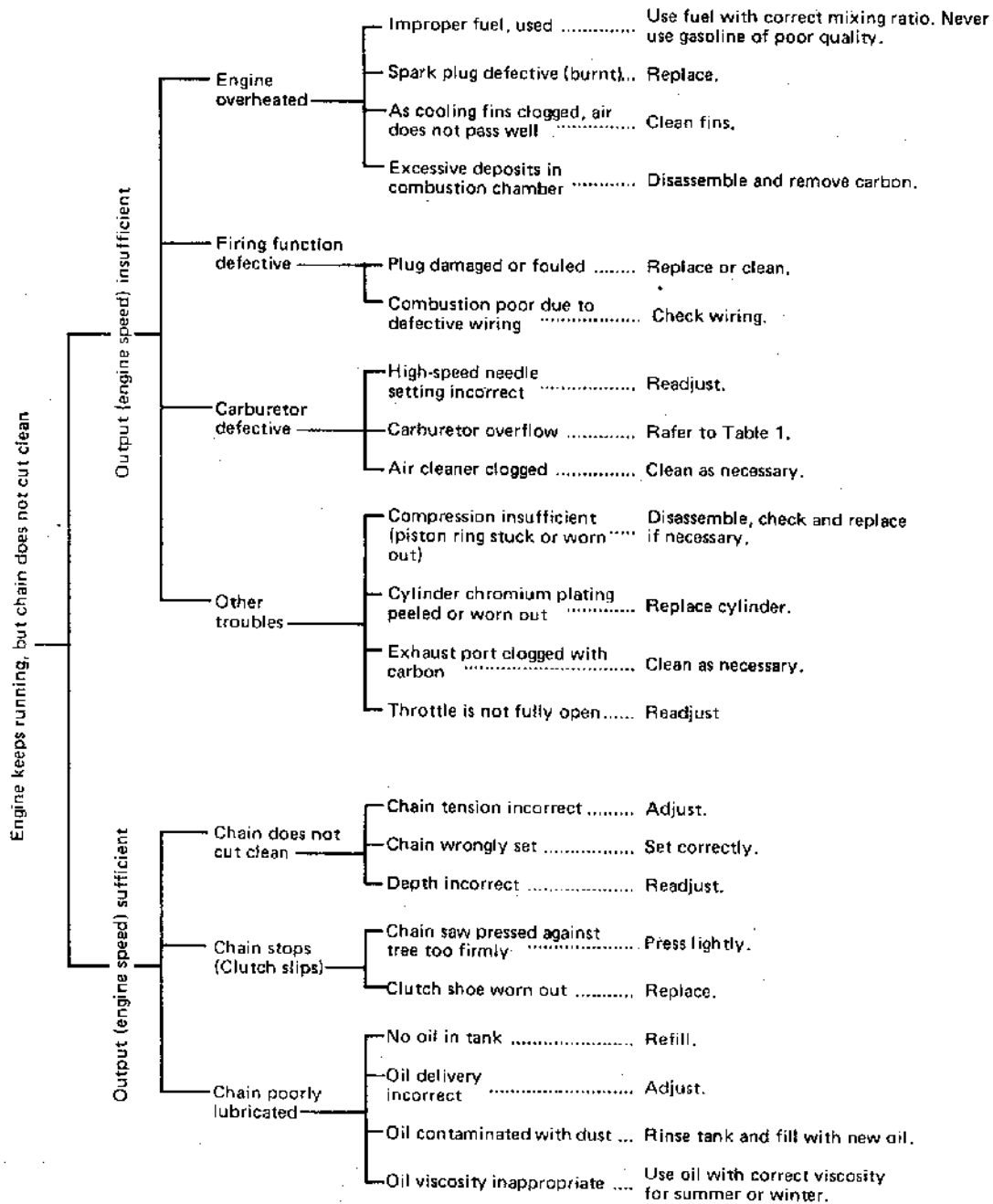

Table 2



STORAGE AFTER USE

- Inspect and adjust every part of the chain saw.
 - Completely clean every part, and repair, if necessary.
 - Apply thin coating of oil on metal parts to prevent rust.
 - Remove chain and guide bar, apply sufficient oil coating and wrap them up in plastic.
- Drain fuel tank, pull starter slowly a few times to drain fuel from carburetor.
- Pour a small amount of clean motor oil into spark plug hole, pull starter and crank the engine until the TOP DEAD CENTER.
- Store in a dry area, free from dust.

E KIORITZ CORPORATION

5-1, SHIMORENJAKU 7-CHOME, MITAKA, TOKYO 181, JAPAN
PHONE:0422-48-6115 P.O. BOX 10 MITAKA TOKYO
CABLE ADDRESS:KIORITZ MITAKA TELEX:KIORITZ A J26592

ECHO

CAP INDICATION

Fuel/oil tanks are indicated by the following illustrations on the caps.



FUEL TANK CAP



OIL TANK CAP