



MANUEL D'ATELIER

Moteur motoculteur

KS650D

**Model TS-TSC
Model ES-ESC**



Yvan Béal - 21, av. de l'Agriculture - B.P. 16
Z.I. du Brézet - 63014 Clermont-Ferrand Cedex 2
Tél : 04 73 91 93 51 - Télécopie : 04 73 90 23 11
www.yvanbeal.fr - E-mail : info@yvanbeal.fr
R.C.S. Clermont-Fd B 304 973 886 S.A.S. au capital de 612 000 €

02-00062-080924

CONTENTS

1. FEATURES AND STRUCTURE OF MODELS ES(C) & TS(C).....	1
2. SPECIFICATIONS OF ES(C) & TS(C).....	3
3. CONSTRUCTION AND FEATURES OF CONDENSER TYPE COOLING SYSTEM	5
4. LUBRICATING SYSTEM	6
5. FUEL SYSTEM	8
6. SELLING POINTS	10
7. DISASSEMBLY, REASSEMBLY AND ADJUSTMENT PROCEDURES	12
1) DISASSEMBLY	13
2) REASSEMBLY	25
8. DISASSEMBLY AND REASSEMBLY OF MAJOR COMPONENTS	38
1) FUEL INJECTION PUMP (Deckel type) (Bosche type).....	38
2) FUEL INJECTION VALVE	48
9. ADJUSTMENT OF PRINCIPAL COMPONENTS	55
1) INTAKE, EXHAUST VALVE CLEARANCE	55
2) GOVERNOR LINKAGE ADJUSTMENT	56
10. DISASSEMBLY AND REASSEMBLY OF MODELS ES(C) & TS(C) CONDENSERS	60
1) DISASSEMBLY	60
2) REASSEMBLY	64
11. ADJUSTMENT STANDARD	67

5. FUEL SYSTEM

1. FEATURES

To prevent fuel injection pump and fuel injection valve from damaging due to foreign material, double filter system is used.

The fuel injection mechanism is of instantaneous adjustment type to respond any load fluctuation. The fuel line is designed for safe operation even in inclined fields.

- 1) **Fuel Filter** 1st filter is provided at top of the fuel tank. At the lower part of the fuel tank, 2nd filter having 10 to 15 micron paper filter element is mounted.
- 2) **Fuel Piping** The material of fuel pipe has weather-proof and anti-oil characteristics. The fuel pipe layout is made to provide good flow of fuel in any inclined position.
- 3) **Fuel injection pump** ..It is interconnected with the all speed governor to feed adequate fuel.
O-ring is used in the regulator to make the operation of regulator smooth, and to prevent oil leaks. This super-precision pump has high durability.
- 4) **Fuel injection valve** ... The valve changes the fuel from the pump into fine jet flow. In addition to special whirlpool combustion chamber, it presents superior starting, combusting and power characteristics.

2. LUBRICATION SYSTEM DIAGRAM

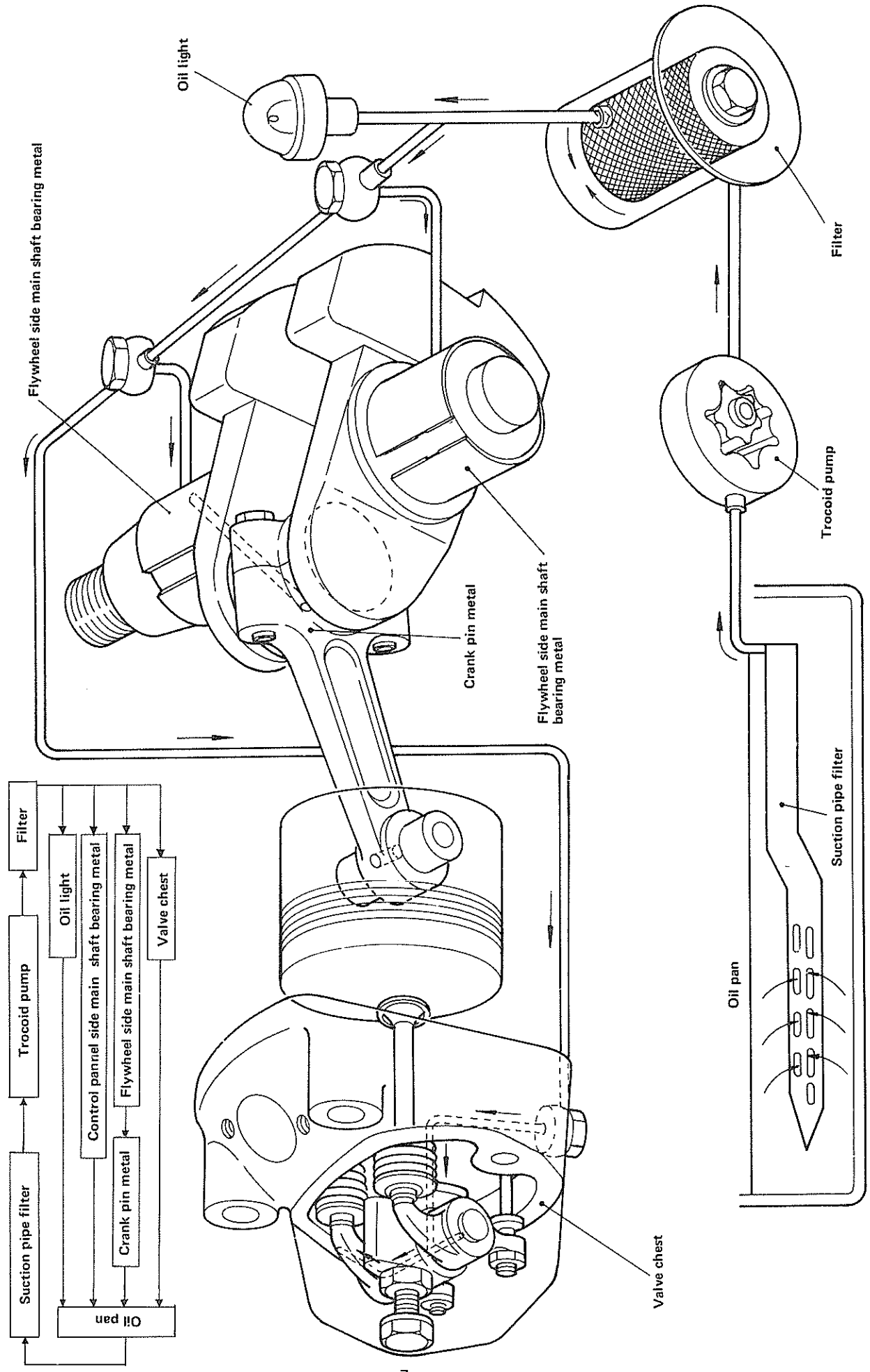

4. LUBRICATING SYSTEM

1. FEATURES

Perfect-sealed, forced lubrication system is employed. The trochoid pump is equipped with lubricating oil filter.

Lubricating condition can be checked easily with the rotating type oil light. Inspection and adding of oil can be done from the lubricating oil filler opening provided at front part. The oil drain plug is mounted at the lower front part of crankcase.

- 1) **Trochoid pump** It operates stably in all operating conditions from low to top engine speed. The oil feed pressure is 2kg/cm^2 .
- 2) **Lubricating oil filter** A suction pipe filter and a steel net filter are employed.
- 3) **Oil light** It shows lubricating condition during operation.
- 4) **Metals** These are sufficiently lubricated without having alteration in material characteristics.
- 5) **Piston liner** It is always lubricated properly by splashed oil.
- 6) **Cylinder head and valve rocker chamber** Intermittent lubricating type is employed.
- 7) **Lubricating oil line** Lubricating oil pump and filter are housed inside the cover at cylinder side to minimize the length of oil line. It also prevents oil leakage.

3. CONSTRUCTION AND FEATURES OF CONDENSER TYPE COOLING SYSTEM

1. CONSTRUCTION

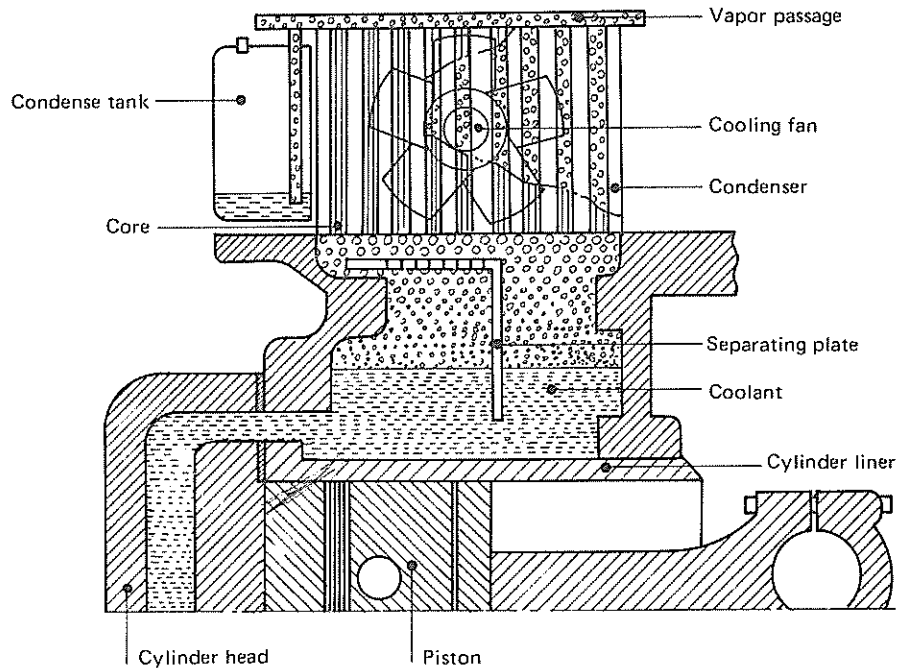

2. FUNCTION

- (1) When coolant temperature is raised by engine operation, the fluid is vaporized to stick on the condenser tube. This vapor adhered on the tube is, then, cooled down by cool wind from the cooling fan. The vapor becomes water at this time to return in the engine cylinder.
- (2) When heavy load is applied on the engine, air and vapor are stored in the condense tank. Only the air escapes from this tank. When the load is decreased, the pressure in the tank is decreased. Thus, water in the condense tank is returned to the condenser. Therefore, the coolant loss in the system is very little resulting in long time operation without coolant replenishment.

3. FEATURES

- (1) The coolant can be used for more than 100 operating hours.
- (2) Since vapor only is entered in the condenser, the center of gravity is low resulting in stable balancing.
- (3) Only the vapor enters into the core. Therefore, radiation efficiency is great. Furthermore, it is designed so that dust will not affect the cooling efficiency.
- (4) Coolant temperature in the cylinder is always maintained around 100°C . This condition is ideal for engine and lubricant temperature to minimize engine damages.

Model	TS50	TS50C	TS60	TS60C	TS70	TS70C	TS80	TS80C
Type	4-cycle, horizontal diesel engine							
No. of cylinder	1							
Bore x stroke mm	70 x 70		75 x 75		80 x 75		80 x 85	
Displacement ℓ	0.269		0.331		0.377		0.427	
Continuous rating output HP/rpm	4/2000		5/2000		6/2200		7/2200	
1-hr. rating output HP/rpm	5/2400		6/2400		7/2400		8/2400	
Specific fuel consumption g/HPh	215		210		210		210	
Compression ratio	24.5		23.1		21.2		21.0	
Combustion system	Precombustion chamber							
Lubrication system	Forced lubrication with trochoid pump							
Cooling system	Hopper	Condenser	Hopper	Condenser	Hopper	Condenser	Hopper	Condenser
Starting system	Hand							
Fuel tank capacity ℓ	5.5		6.5		8.0		9.5	
Oilpan capacity ℓ	1.5		1.7		2.2		2.3	
Cooling water capacity ℓ	6.5	1.3	7.5	1.7	9.0	2.0	9.5	2.2
Dry weight Kg (lbs)	58 (127)	63 (138)	64 (141)	69 (152)	76 (167)	81 (178)	82 (180)	86 (189)

Model	TS105	TS105C	TS130	TS130C	TS155	TS155C	TS180	TS180C
Type	4-cycle, horizontal diesel engine							
No. of cylinder	1							
Bore x stroke mm	85 x 90		92 x 95		95 x 106		102 x 106	
Displacement ℓ	0.510		0.631		0.751		0.866	
Continuous rating output HP/rpm	9/2200		11/2200		13/2200		15/2200	
1-hr. rating output HP/rpm	10.5/2400		13/2400		15.5/2400		18/2400	
Specific fuel consumption g/HPh	210		205		205		205	
Compression ratio	20.9		20.3		20.4		19.5	
Combustion system	Precombustion chamber							
Lubrication system	Forced lubrication with trochoid pump							
Cooling system	Hopper	Condenser	Hopper	Condenser	Hopper	Condenser	Hopper	Condenser
Starting system	Hand							
Fuel tank capacity ℓ	10.0		11.0		14.0		17.5	
Oilpan capacity ℓ	3.0		3.0		3.2		3.5	
Cooling water capacity ℓ	10.9	2.3	12.4	2.5	16	3.2	18	3.2
Dry weight Kg (lbs)	85 (187)	91 (200)	101 (222)	108 (238)	146 (321)	153 (337)	155 (341)	163 (359)

2. SPECIFICATIONS

Model	ES50	ES60/ES60C	ES70/ES70C	ES80/ES80C
Type	4-cycle horizontal diesel engine			
No. of cylinder	1			
Continuous output (HP/rpm)	4/2200~4.5/2400	5/2200~5.5/2400	6/2200~6.5/2400	7/2200~7.5/2400
Maximum output (HP/rpm)	5/2400	6/2400	7/2400	8/2400
Combustion system	Pre-combustion chamber			
Lubrication system	Forced lubrication with gear pump(totally enclosed type)			
Cooling system	Water cooling with hopper	Water cooling with hopper / condenser		
Starting system	Hand			
Fuel tank capacity (ℓ)	5.5	6.5	8.9	9.5
Lub. oil capacity (ℓ)	1.5	1.7	2.2	2.3
Cooling water capacity (ℓ)	6.5	7.5/1.7	9.0/2.0	9.5/2.2
Lighting equipment	6V-25W			
Weight (dry) (kg)	60	66/71	78/83	84/88
Model	ES105C	ES120C	ES130C	ES155C
Type	4-cycle horizontal diesel engine			
No. of cylinder	1			
Continuous output (HP/rpm)	8/2000~9/2200	9/2000~10/2200	10/200~11/2200	12/2000~13.5/2200
Maximum output (HP/rpm)	10.5/2400	12/2400	13/2400	15.5/2400
Combustion system	Pre-combustion chamber			
Lubrication system	Forced lubrication with gear pump totally enclosed type)			
Cooling system	Water cooling with condenser			
Starting system	Hand			
Fuel tank capacity (ℓ)	10.0	11.0	11.0	14.0
Lub. oil capacity (ℓ)	3.0	3.0	3.0	3.2
Cooling water capacity (ℓ)	2.3	2.5	2.5	3.2
Lighting equipment	6V-25W			
Weight (dry) (kg)	93	110	131	155

7. BRIGHT ILLUMINATION

Improved generator keeps off decrease voltage fluctuation.

Excellent reflecting factor

Aluminium evaporated reflecting plate

8. SUPERIOR INCLINED OPERATION

An improved breather and fuel lines are used to obtain stable operation even when inclined.

Employed special breather

Complete fuel piping

As down-flow piping system is employed, more smooth fuel flow is realized.

No oil stain and no oil leakage

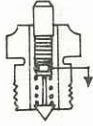

O-ring is set in the fuel pump.

Easy to mount

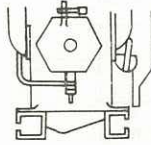

Oil pan level is higher than the setting legs.

Transparent oil pan presents oil level and tired condition of oil at a glance.

Positioned over the setting base and easy handling

Mounted compact

Easy to check the oil level

Less piping and no fuel leakage

Easy to mount and dismount

Transparent ball presents filter condition and remained water at a glance.

9. EASY MAINTENANCE AND HANDLING

All control levers and knobs are gathered at a place. Perfectly sealed and forced-lubrication system is employed.

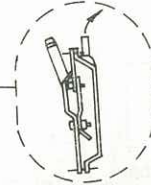

* The engine excluding the one drawn oblique lines shows the model TS-C.

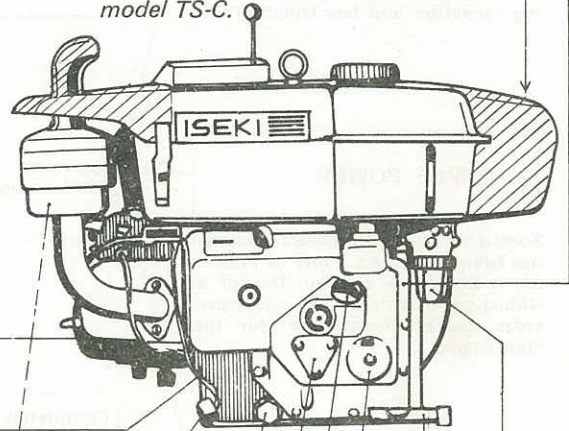

1. FEATURES AND STRUCTURE

OF MODELS ES(C) & TS(C)

1. EASY STARTING

The special combustion chamber mixes fuel with air idally. And big-size intake valve improves compression pressure, resulting in easy starting operation and less frinction loss.

Special magnet

2. AMPLE POWER

Special wirlpool combustion chamber has been developed. Flow of intaken air is improved. Friction loss of at sliding parts is decreased, these provides excess horsepower for this class engine.

Improved whirlpool type pre-combustion chamber

3. LOW NOISE LEVEL

Muffler and valve mechanism have been improved to minimize the noise.

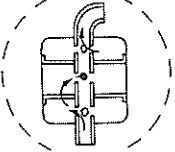

Completely sealed lubrication system

Double step type muffler

Refrained oil stain and proper lubrication of valve guide and rocker arm bearing

4. HIGHLY EFFICIENT CONDENSER COOLING SYSTEM

Iseki's super condenser (patented) provides top cooling condition at all time.

Open/shut type condenser screen prevents the condenser from dust.

Hopper type cooling system

5. RESTRICTED VIBRATION

Well balanced engine design being matched with the tiller restricts the operating vibration. (Special balancer and new perfect balancer are employed.)

Precisely processed thin cylinder

Reduced weight of reciprocating section

6. COMPACT IN SIZE AND LIGHT IN WEIGHT

The engine is specially designed for mounting on the tiller.

Special eccentric and single-axle balancer employed

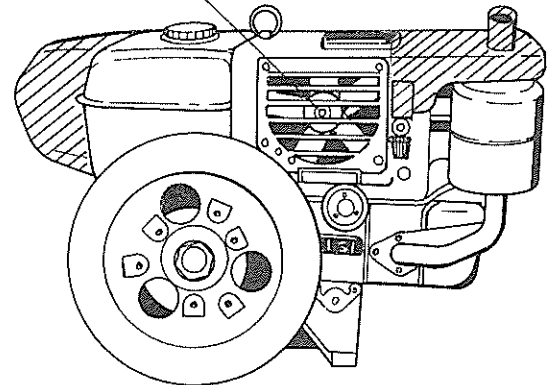
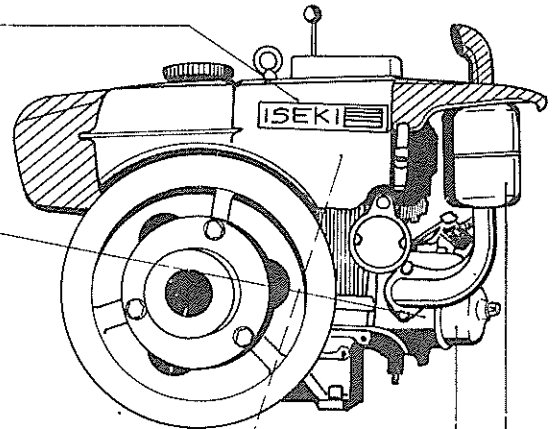

* The engine excluding the one drawn oblique lines shows the model TS-C.

2. FUEL SYSTEM DIAGRAM

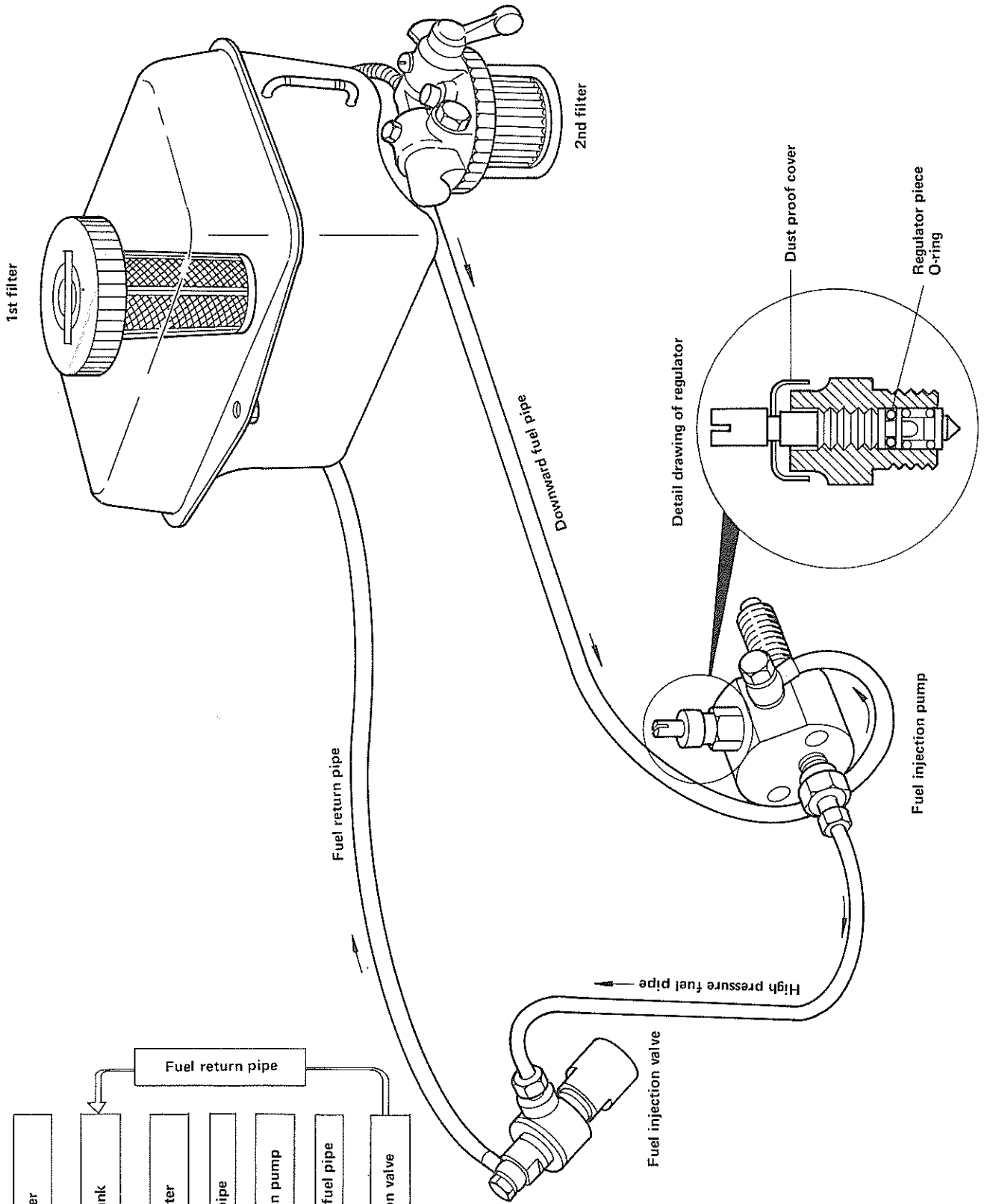
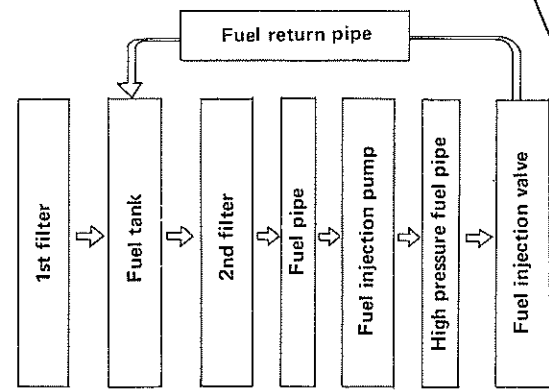

6. SEELING POINTS

1. EASY OPERATION

* ISEKI's special whirlpool precombustion chamber, big-size intake valve display the easiest starting of the engine.

"The engine starts easily without any auxiliary starting aid".

2. QUIET!!

The weight of reciprocating movement section being the source of vibration is minimized. Furthermore, ISEKI's unique special balancers (SS70 – 90 and SS11 – SS13) are employed.

Double stage muffler employed gives quiet yet high-power operation.

"Quiet and comfortable operation are resulted."

3. TOUGH!!

* Flat torque in any speed range.

Patented special precombustion chamber burns fuel perfectly putting out high combustion power. Moreover, it is a really tenacious engine.

* High efficient air intake with big intake valve.

High compression pressure and high intaken air temperature are resulted. High and constant torque is provided in low to top speed with powerful combustion.

"It is one of the toughest engine".

4. SIMPLE AND EASY MAINTENANCE

All engine controls ... Check before start – Start – Accelerator control – Stop, Oil supply – Oil drain ... is made at operator's side easily and safely.

* Lubrication oil filter, fuel filter and air cleaner are located at one side. It is easy to service them.

* Open/shut type condenser screen is employed to enable cleaning of the condenser with one touch of the knob.

* Transparent ball type air cleaner is used. Oil condition and oil level are easy to check.

* Transparent fuel filter is mounted. The condition of fuel is easily observed without mistake.

5. Smooth and Accurate Operation

* Model ES-C diesel engine has condenser type cooling system. It maintains the engine at top condition even in sudden load fluctuation or under hot weather.

* The trochoid type lubricating oil pump sends ample oil under any operating conditions.

* Large fuel tank helps long and continuous operation.

6. Bright Light

High-speed and high-power generator with special magnet attached generates ample current even under low speed operation. The aluminum reflection plate provides nearly 100% reflecting ratio.

“The bright light makes night work comfortable.”

7. Reliable

Special breather is employed in lubricating system. Fuel pipe is lines for inclined operation.

8. Durable

* Barrel face type piston top ring is easy to bedded in. It improves not only performance but durability of the ring and liners.

* Parabolic cam is used for valve mechanism to follow sudden alteration of operating load.

This provides stable performance and high durability.

7. DISASSEMBLY, REASSEMBLY, AND ADJUSTMENT PROCEDURES

CAUTIONS

- Disassembly and reassembly procedures are given for the engine and principal components. In practice in the case of localized trouble, service at the trouble point only is required. Note, however, that failure to understand the entire system will lead to less than satisfactory work. In this manual, disassembly and reassembly work has been described in a series of basic steps. Please study this information carefully, to gain full comprehension of the work at hand.
- In practice, disassemble only the parts necessary to effect repair.
- Arrange parts in order during the disassembly phase, thereby making reassembly as smooth as possible.
- Before proceeding with reassembly work, wash all parts well and coat areas subjected to friction with engine oil.

1) DISASSEMBLY

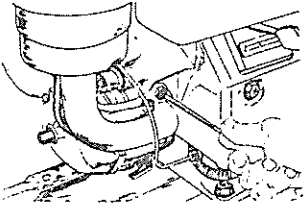
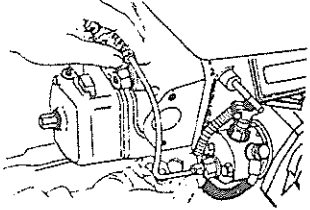
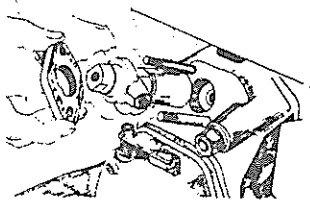
Item		Q'ty	Procedure & cautions	Model	Tools	Figure
1.	Oil Air cleaner and intake pipe	1	(1) Draw out the lubrication oil. (2) Remove the air cleaner and intake pipe. Note: Remove the wing nut at the top. Clean the interior and make sure that the oil level is correct.	Whole	Philips screwdriver, 13 mm wrench Wrench 17 mm [TS180(C)]	
2.	Exhaust silencer	1	(1) Remove the exhaust silencer and gasket. Note: Do not allow the gasket to drop out.	Whole	Philips screwdriver, 13 mm wrench	
3.	Fuel injection nozzle Fuel return pipe Fuel injection pipe Fuel injection valve retainer	1 1 1	(1) Disconnect the fuel return pipe at the fuel injection nozzle. (2) Remove the fuel injection pipe. Note: Remember which is the top and which is the bottom end. Fuel pump end Fuel nozzle end (3) Remove the fuel injection valve retainer. Note: Remember which is the front and which is the back of the piece.	Whole	Wrench 13 mm Wrench 13 mm Wrench 14 mm [TS180(C)] Wrench 19 mm [TS180(C)] Wrench 13 mm Wrench 19 mm [TS180(C)]	 

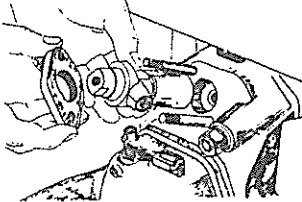
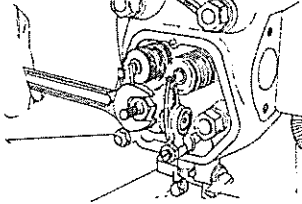
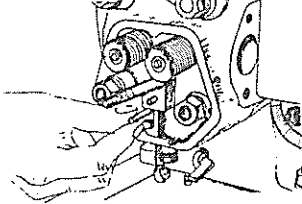
Item	Q'ty	Procedure & cautions	Model	Tools	Figure
		(4) Remove the fuel injection nozzle. Note: Remember the position of the arrow at the fuel injection pipe end.		By hand	
4.	<p>Cylinder head</p> <p>Rocker arm case</p> <p>Intake-exhaust rocker arm assembly</p> <p>Valve push rod</p> <p>Lub. oil pipe</p> <p>Cooling water pipe</p>	<p>(1) Drain water from the hopper.</p> <p>(2) Remove the rocker arm case.</p> <p>Note: (Be) carefully to avoid damage to the packing.</p> <p>(3) Remove the intake-exhaust rocker arm assembly. Note: Remember which is the front and which is the back of the convex washer of the rocker arm support.</p> <p>(4) Remove the push rods.</p> <p>(5) Disconnect the head end of the lub. oil pipe.</p> <p>Note: Take care not to lose the copper packing.</p> <p>Remove the water pipe from the cylinder head side.</p>	Whole	<p>Wrench 13 mm</p> <p>Philips screw-driver [TS180(C)]</p> <p>Wrench 10 mm [TS180(C)]</p> <p>Wrench 17 mm</p> <p>Wrench 19 mm [TS180(C)]</p> <p>By hand</p> <p>Wrench 13 mm</p> <p>Wrench 10 mm and/or screw driver</p>	 

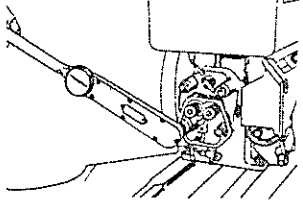
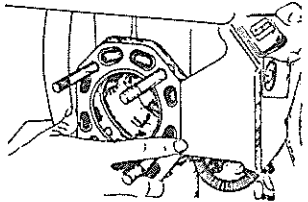
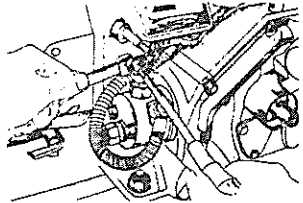
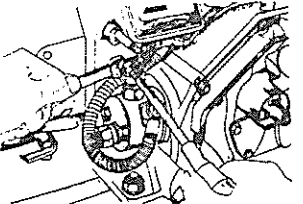
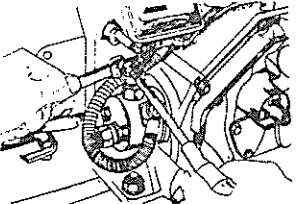
Item	Q'ty	Procedure & cautions	Model	Tools	Figure
Cylinder head	1	(6) Remove the cylinder head. (Remove the nuts and washers.)		Wrench Wrench 24 mm [TS180(C)]	
Gasket packing	1	(7) Remove the gasket packing.			
5. Fuel injection pump Cylinder side cover	1	(1) Remove the cylinder side cover.	ES50(C) TS50(C) ? ES155(C) TS155(C)	Philips screwdriver	
Pump adjusting lever link screw	1	(2) Loosen the nut of the pump adjusting lever link screw.		Wrench 17 mm	
		(3) Remove the pump adjusting lever link screw.		Flat screwdriver	
		(4) Close the fuel tank cock.			

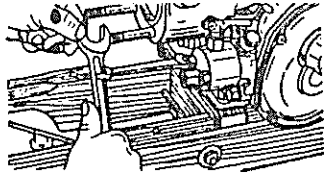
Item	Q'ty	Procedure & cautions	Model	Tools	Figure
<p>Fuel injection pump</p> <p>Injection timing adjustment shim</p>	1	<p>(1) Close the fuel cock.</p> <p>(2) Disconnect the fuel pipe at the injection pump side.</p> <p>Note: Do not lose the copper packing.</p> <p>(3) Remove the fuel injection pump.</p> <p>Note: Align the rack with the cutaway portion of the cylinder body and remove the injection pump.</p> <p>Remove the injection timing adjustment shims. Note the number of shims used.</p>	TS180(C)	<p>Wrench 17 mm</p> <p>Wrench 13 mm</p>	
Fuel pipe	1	<p>(5) Disconnect the fuel pipe at the fuel injection pump.</p> <p>(6) Remove the fuel injection pump nuts. Note: To remove the inside nut, use two wrenches as shown in the figure.</p>	Whole	<p>Wrench 13 mm</p> <p>Wrench 13 mm</p>	

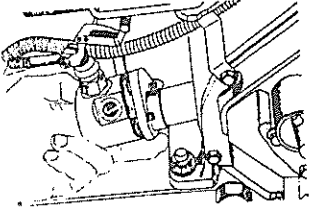
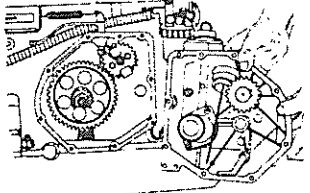
Item	Q'ty	Procedure & cautions	Model	Tools	Figure
		<p>(7) Remove the fuel injection pump. Note: Proceed carefully so that parts do not drop out.</p> <ul style="list-style-type: none"> ● Exercise care to avoid damage to the pump packing. ● Remove the pump mounting base at the same time. <p>Note: The number of shims used.</p>			
<p>6. Cylinder side cover</p> <p>Starting handle</p>	<p>1</p>	<p>(1) Remove the starting handle.</p> <p>(2) Remove the cylinder side cover bolts. Then detach the cylinder side cover.</p>	<p>Whole</p>	<p>Wrench 10 mm</p>	
<p>Oil level gauge, cylinder side cover assembly</p>	<p>1</p> <p>1</p>	<p>(3) Remove the oil level gauge.</p> <p>(4) Remove the cylinder side cover bolts.</p>	<p>TS180(C)</p> <p>TS180(C)</p>	<p>Wrench 10 mm</p>	

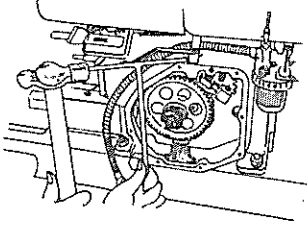
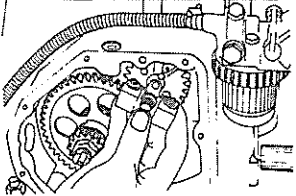
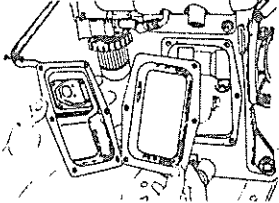
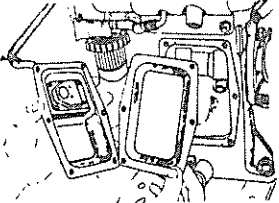
Item	Q'ty	Procedure & cautions	Model	Tools	Figure
7. Governor Governor lever shaft	1	<p>(1) Remove the governor lever shaft pin. Note: This pin is tapered. Pull it from the rear cover side.</p> <ul style="list-style-type: none"> ● Proceed carefully to avoid bending the regulator spring. 	Whole		
	2	<p>(2) Remove the governor mounting bolts.</p> <p>(3) Remove the governor assembly. Note: Turn the fly-wheel to bring the two weights in a vertical line. With a screwdriver inserted between the top weight and the body, pry loose the governor assembly.</p>		<p>Philips screw-driver</p> <p>Wrench 10 mm and or Philips screw-driver</p>	
8. Cylinder rear cover	1	<p>(1) Remove the cylinder rear cover mounting bolts and separate the cylinder rear cover.</p> <p>Note: Remove the breather pipe at the same time. Slightly extend the breather pipe support.</p>	Whole	Philips screw-driver	
Cylinder shield		<p>(2) Remove the cylinder shield.</p>			

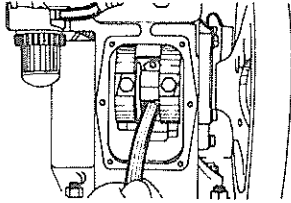
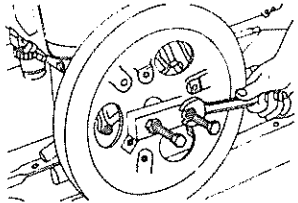
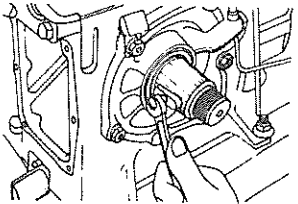
Item	Q'ty	Procedure & cautions	Model	Tools	Figure
Piston and connecting rod assembly		<p>(5) Remove the piston and connecting rod assembly.</p> <p>Note: Using the hammer handle, gently drive the piston and connecting rod assembly upward. Force should be applied at the surface which contacts the rod cap. Proceed carefully to avoid dropping the bearing insert.</p>		Hammer	
10. Flywheel end nut	1	(1) Remove the end nut.	Whole	End nut wrench and hammer	
	1	<p>(2) Remove the flywheel. Note: Use the special tool for this work.</p> <ul style="list-style-type: none"> ● Position the tool in parallel with the end surface of the crankshaft. ● Thread the bolts well into the flywheel holes. Then tighten the nuts alternately and evenly. 		Flywheel puller and 21 mm wrench	
Flywheel key	1	(3) Remove the flywheel key. Note: Always use the bolt for this work.		Side cover mounting bolt Wrench 10 mm Bolt 6 mm	

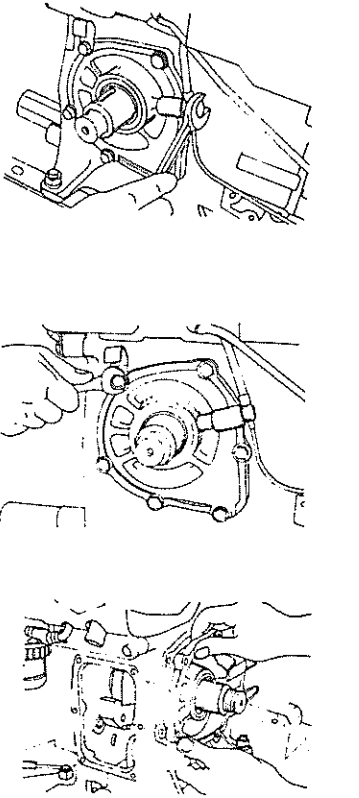
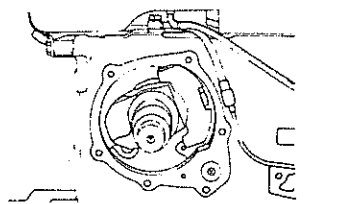
Item	Q'ty	Procedure & cautions	Model	Tools	Figure
11. Main bearing housing Oil pipe	1 5 1	<p>(1) Remove the oil pipe joint bolt.</p> <p>Note: Raise the above pipe to a point above the bearing housing.</p> <p>(2) Remove the main bearing housing mounting bolts.</p> <p>(3) Remove the main bearing housing.</p> <p>Note: Thread side cover mounting bolts of 8 mm into the holes for removing the main bearing housing, forcing the main bearing housing free.</p> <ul style="list-style-type: none"> ● As soon as the main bearing housing comes free, carefully pull off the housing to avoid damage to the oil seal. 	Whole	<p>Wrench 17 mm</p> <p>Wrench . 13 mm Wrench 17 mm [TS180(C)]</p> <p>Hammer</p> <p>Side cover mounting bolt Wrench 13 mm</p>	
12. Crankshaft	1	<p>(1) Move balance weight of the crankshaft to a position for pulling the cylinder block.</p>	Whole		

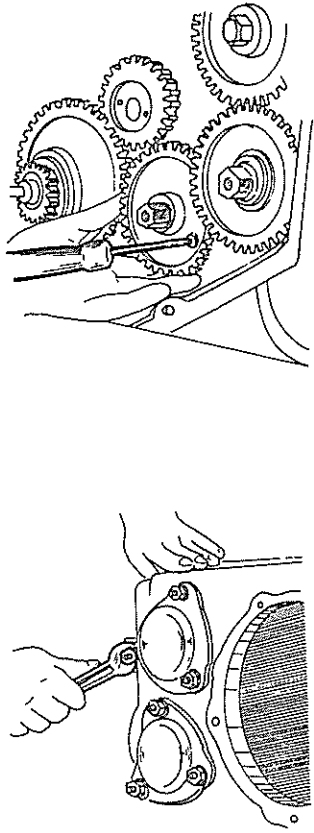
Item	Q'ty	Procedure & cautions	Model	Tools	Figure
	Crankshaft gear	<p>(2) Remove the crankshaft. Note: Insert a philips screwdriver through the governor mounting hole and drive out the crankshaft with a hammer.</p> <ul style="list-style-type: none"> ● Keep one hand on the opposite end to prevent the crankshaft from dropping. ● Pay attention to the thrust bearing on the pump end. <p>(3) Remove the crankshaft gear.</p>		Philips screwdriver Hammer	
13.	Balancer shaft Idle gear Balancer shaft	<p>(1) Remove the idle gear mounting base bolt.</p> <p>(2) Pull the idle gear mounting base assembly.</p> <p>Note: Insert the tip of the screwdriver from the wheel side and tap lightly to free the tapered portion.</p> <p>(3) Remove the balancer shaft cap mounting nuts. (Both top and bottom.)</p> <p>(4) Remove the balancer shaft cap. (Both top and bottom.)</p> <p>Note: Proceed carefully to avoid damage to the packing.</p>	TS180	Philips screwdriver Box wrench 12 mm Flat screwdriver Hammer Wrench 13 mm	

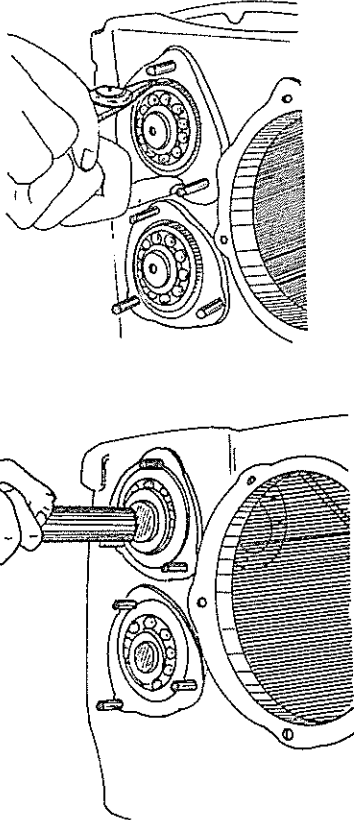
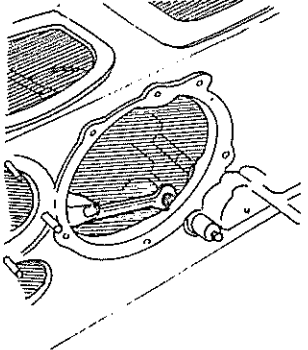
Item	Q'ty	Procedure & cautions	Model	Tools	Figure
		<p>(5) Remove the balancer shaft snap ring.</p> <p>Note: Do not bend the snap ring.</p> <p>(6) Pull the balancer shaft.</p> <p>Note: Position the zinc rod at the wheel end and drive out the shaft with the hammer. Do not allow the shaft to fall out.</p> <ul style="list-style-type: none"> ● Position the weight of the upper balancer at the top, that of the lower balancer at the bottom. As soon as the bearing comes free, turn forward and pull it out slightly. 	TS180(C)	<p>Snap ring pliers Flat screw-driver</p> <p>Zinc rod and hammer</p>	
14.	Oil pump First oil strainer 1	(1) Remove the first oil strainer.	TS180(C)	Wrench 17 mm	

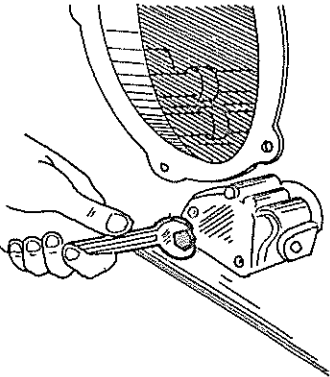
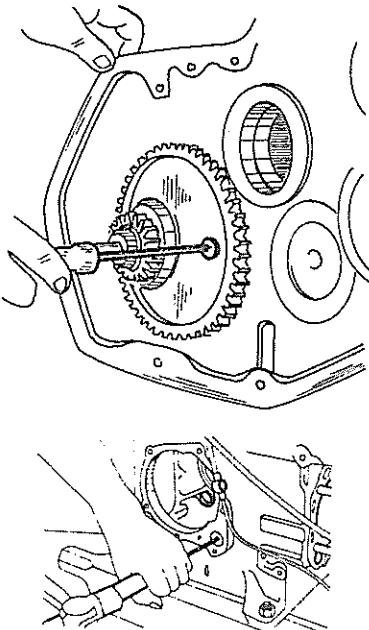
Item	Q'ty	Procedure & cautions	Model	Tools	Figure
		(2) Remove the oil pump.		Wrench 13 mm Wrench 17 mm	
15.	Camshaft	<p>(1) Remove the ball bearing fixing bolt.</p> <p>(2) Remove the camshaft.</p> <p>Note: Insert a screwdriver (from the fly-wheel side) at the oil pump drive portion. Using a hammer, drive the camshaft free.</p>	Whole	<p>Philips screwdriver</p> <p>Flat screwdriver</p>	
16.	Tappet	<p>(1) Remove the tappets.</p> <p>Note: There is no difference between left and right tappets.</p>	Whole		

2) REASSEMBLY

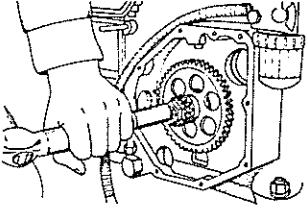
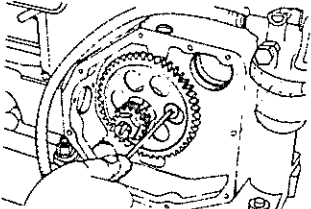
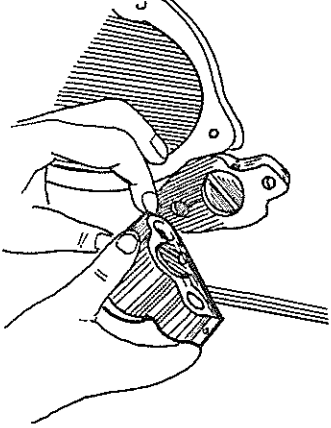
Item	Q'ty	Procedure & cautions	Model	Tools	Figure
1.	Tappet	2 (1) Install the tappets.	Whole		
2.	Camshaft	1 (1) Install the camshaft assembly. Note: Using the handle of the hammer, tap the end of the camshaft. (2) Tighten the ball bearing fixing bolt.	Whole	Zinc rod and hammer Philips screwdriver	 
3.	Oil pump	1 (1) Install the oil pump. Note: Align the drive portion of the oil pump with the cutaway of the camshaft. (2) Secure the pipe line support with one of the 8 mm bolts.	TS180(C)	Wrench 13 mm Wrench 17 mm	

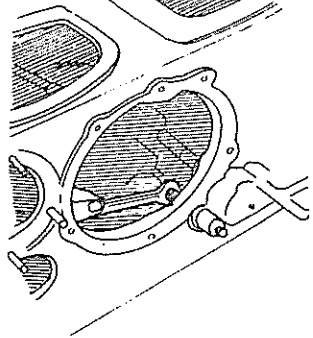
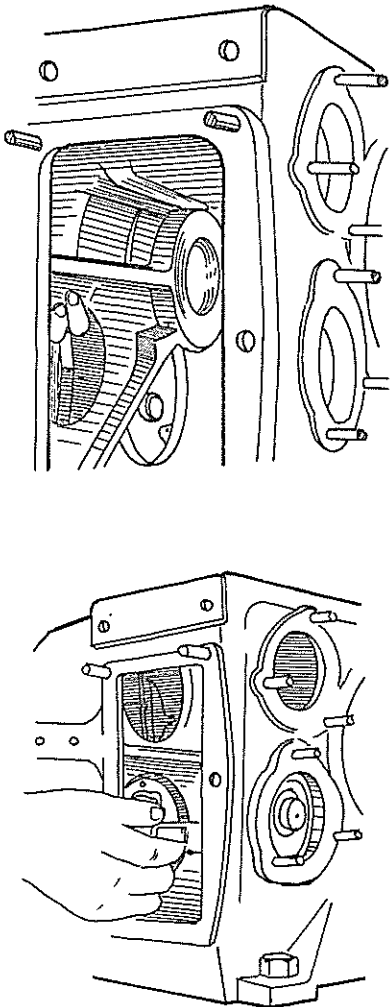
Item	Q'ty	Procedure & cautions	Model	Tools	Figure
		<p>(3) Install the first oil strainer. Note: Make sure that the bottom is in the horizontal plane.</p>		Wrench 17 mm	
4.	Balancer shaft	<p>(1) Insert the upper balancer shaft assembly. Note: Position the weight at the top and turn the shaft while pushing it in.</p> <p>(2) Drive in the upper balancer shaft.</p> <p>(3) Insert the lower balancer shaft assembly. Note: Position the weight at the bottom and turn the shaft while pushing it in.</p>	TS180(C)	Zinc rod and hammer	

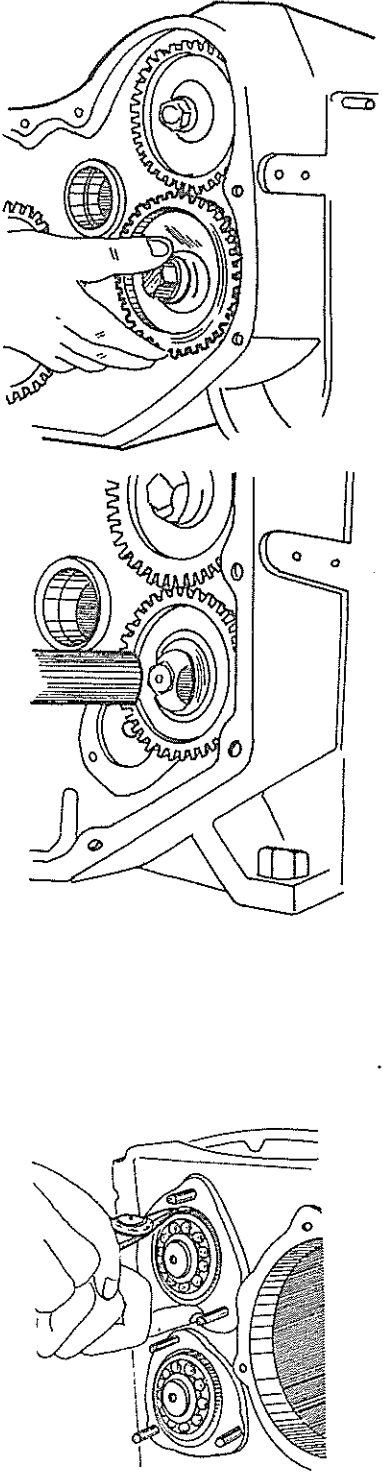
Item	Q'ty	Procedure & cautions	Model	Tools	Figure
		<p>(4) Drive the lower balancer shaft. Note: Proceed so that the balancer shaft does not fall out. Mesh the upper and lower balancer gears at the match marks, after driving in the shaft to that point. Then drive in the shaft completely.</p> <p>(5) Fit the ball bearing snap ring to the flywheel end of the balancer shaft. (Both top and bottom.) Note: Leave the balancer shaft protruding slightly, so that the snap ring groove is exposed. Fit the snap ring into place. Then drive in the balancer shaft to the point at which the snap ring contacts the cylinder surface.</p>		<p>Zinc rod and hammer</p> <p>Snap ring pliers</p> <p>Zinc rod and hammer</p>	

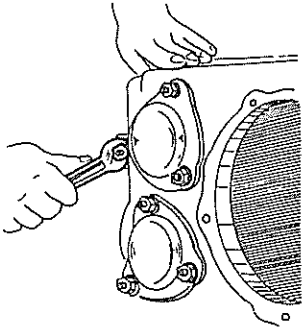
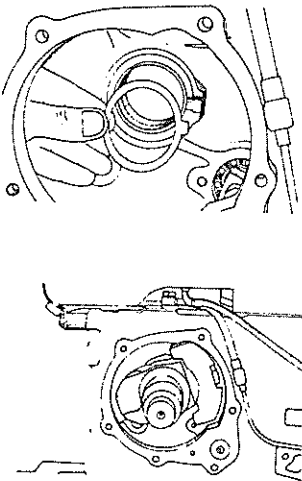
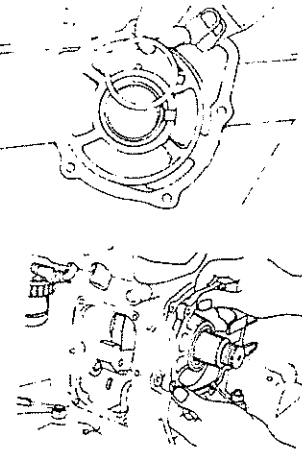
Item	Q'ty	Procedure & cautions	Model	Tools	Figure
		(6) Install the balancer shaft cap. (Both top and bottom.)		Wrench 13 mm	
5.	Crankshaft 1	<p>(1) Install the thrust bearing at the fuel injection pump end of the crankshaft. Note: Place the side with the groove toward the crankshaft.</p> <p>(2) Install the crankshaft. Note: Coat friction surfaces with engine oil or grease.</p>	Whole		
6.	Main bearing housing 1	<p>(1) Install the thrust metal at the flywheel end of the crankshaft. Note: Position the thrust bearing so that the groove is visible.</p> <p>(2) Check the position of the breather pipe support and fit the main bearing housing into place.</p>	Whole	Wrench 17 mm	

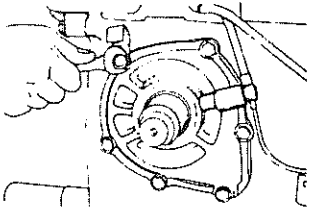
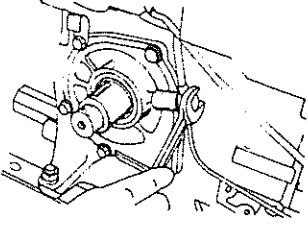
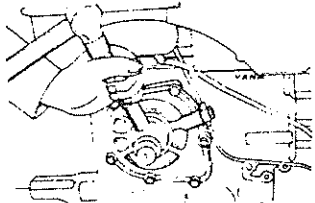
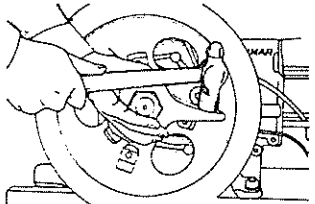
Item	Q'ty	Procedure & cautions	Model	Tools	Figure
Oil pipe	5	(3) Thread in the main bearing housing bolts.		Wrench 13 mm Wrench 17 mm [TS180(C)]	
	1	(4) Connect the oil pipe.		Wrench 17 mm	
7. Flywheel Flywheel key End nut	1	(1) Fit the flywheel key into place. Note: There is no difference between the front and back of the key. ● Drive the key into place with the hammer handle. (2) Install the flywheel. Note: Align the keyway with the key and push the flywheel into place. Thread on and tighten the end nut. (3) Tighten the end nut with the end nut wrench and hammer as shown in the figure. Note: Make sure that the end nut is firmly tightened.	Whole	Hammer Hammer End nut Wrench	 

Item	Q'ty	Procedure & cautions	Model	Tools	Figure
8. Piston and connecting rod assembly	1	<p>(1) Stagger piston ring ends at 90° intervals.</p> <p>(2) Place the mark on the large end of the connecting rod upward.</p> <p>(3) Install the crank pin metal.</p> <p>(4) Align the TD mark on the flywheel with the arrow on the hopper.</p> <p>(5) Using the piston ring compressor, install the piston.</p> <p>Note: Install so that the mark at the large end of the connecting rod faces upward.</p>	Whole	Piston ring compressor	

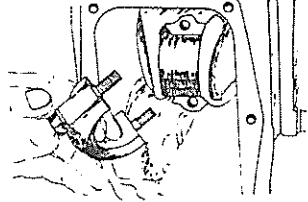
Item	Q'ty	Procedure & cautions	Model	Tools	Figure
Connecting rod bolt		<p>(6) Push down on the head of the piston with the hammer handle and turn the flywheel at the same time, forcing the piston to bottom dead center.</p> <p>(7) Place the marked side of the crank pin metal cap upward and fit the cap into place.</p> <p>Note: Insert in the case of TS180 (C) from the bottom of the lower balancer shaft.</p>		Hammer	
		<p>(8) With lock washer in place, tighten the connecting rod bolts to the specified torque.</p> <p>Note: Tighten the top and bottom evenly. Make sure that the bolts do not fall inside.</p> <p>(9) Bend the locks to keep the bolts from turning.</p>		Box wrench 13 mm and Torque wrench Wrench 17 mm [TS180(C)] Flat screw- driver	

Model	ES50(C) TS50(C)	ES60(C) TS60(C)	ES70(C) TS70(C)	ES80(C) TS80(C)	ES105(C) TS105(C)	ES130(C) TS130(C)	ES155(C) TS155(C)	TS180(C)
Tightening torque kg-m	1.93	1.93	2.76	2.78	3.75	4.7	4.7	5.00

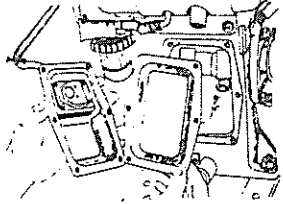
9.	Cylinder rear cover	1	(1) Install the cylinder rear cover.	Whole	Wrench 10 mm Philips screwdriver Wrench 13 mm [TS180(C)]	
----	---------------------	---	--------------------------------------	-------	--	---

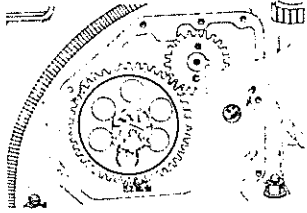
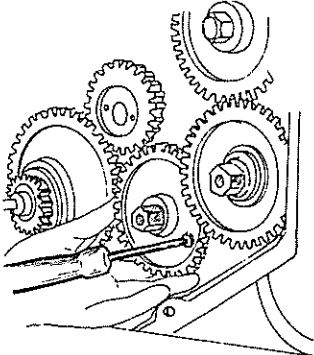
	Item	Q'ty	Procedure & cautions	Model	Tools	Figure
			<p>(2) Secure the breather pipe support of the main bearing housing. Insert the end in the oil pipe. Note: Direct attention to the baffle.</p>			
10.	Crankshaft gear	1	<p>(1) Align 0-marks of the crankshaft and camshaft gears along with key and keyway and fit the crankshaft gear into place. Note: Using the hammer handle, drive the gear to a point at which it is flush with the camshaft gear.</p>	Whole	Zinc rod and hammer	
11.	Idler gear	1	<p>(1) Install the idle gear and mounting base.</p> <p>Note: Make sure that the marks are aligned.</p> <p>1. Make sure that the 00-mark of the upper balancer shaft and the 0-mark of the lower balancer shaft are aligned.</p> <p>2. Align the 00-mark of the crankshaft gear and the 0-mark of the idle gear, along with the M-mark of the lower balancer shaft gear and the M-mark of the idle gear.</p>	TS180(C)	Box wrench 12 mm Philips screwdriver	

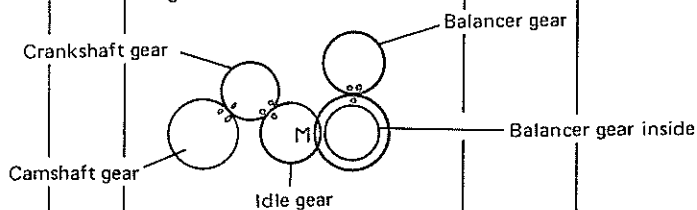

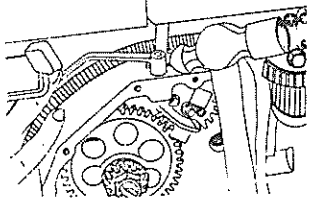
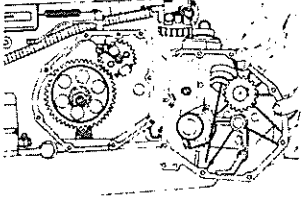
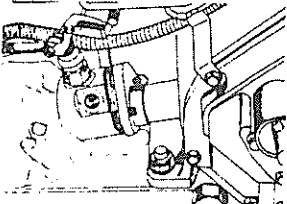
Item	Q'ty	Procedure & cautions	Model	Tools	Figure
12. Governor assembly		<p>(1) Tighten the governor mounting bolts.</p> <p>(2) Install the governor lever shaft. Note: Make sure that positioning of the regulator spring end is correct.</p> <ul style="list-style-type: none"> ● Drive in the tapered pin from the rear cover side. 	Whole	<p>Box wrench 10 mm Philips screwdriver</p> <p>Hammer Philips screwdriver</p>	
13. Cylinder side cover	1	<p>(1) Install the cylinder side cover. Note: Align the oil pump drive shaft with the camshaft groove.</p> <ul style="list-style-type: none"> ● Make sure that the fuel pipe retainer is correctly positioned. 	Whole	Wrench 10 mm	
14. Fuel injection pump	1	<p>(1) Install the fuel injection pump base and the fuel injection pump. Note: Pay attention to positioning of the plunger spring support.</p>	Whole	Box wrench 13 mm	

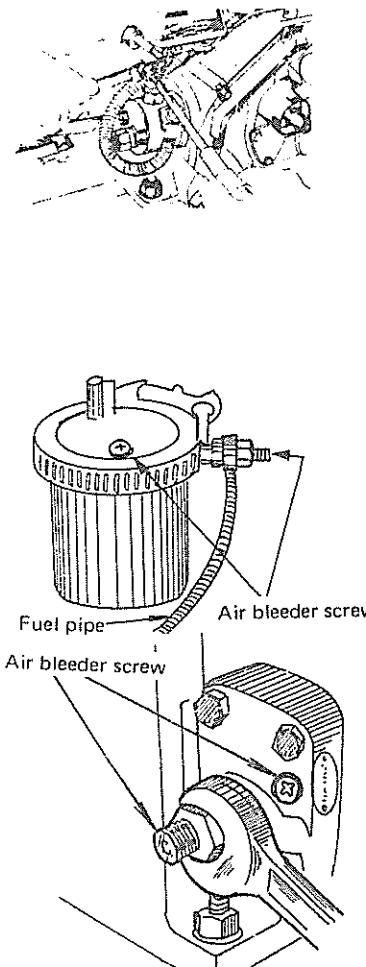
Item	Q'ty	Procedure & cautions	Model	Tools	Figure
		Install the fuel injection pump Note: Align the rack to the cutaway position of cylinder body. And insert the rack while setting governor lever. o Don't forget the adjusting shim for injection timing. Adjustment can be done by the thickness of shim: 0.1 mm varies 1°	TS180(C)		
Fuel pipe		(2) Connect the fuel pipe. (3) Thread in the pump adjusting lever link screw. (4) Adjust the air bleeder and governor lever. (5) Open the fuel cock. (In the case of TS180 (C)), Bleed air from the fuel pump in the following sequence. 1. Air bleeder screw of the fuel strainer. 2. Air bleeder screw of the fuel pipe. 3. Air bleeder screw of the fuel pump. (6) Adjust the governor lever.	Whole TS180(C)	Wrench 17 mm Philips screwdriver Refer to pertinent information. Philips screwdriver Refer to pertinent instructions.	

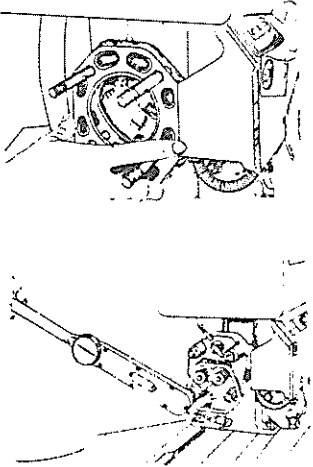
Item	Q'ty	Procedure & cautions	Model	Tools	Figure
15. Cylinder side cover	1	(1) Install the cylinder side cover.	Whole	Philips screwdriver	
16. Cylinder head	1	(1) Install the cylinder head. Note: Make sure that the gasket is positioned correctly.	Whole	Wrench 19 mm Torque wrench Wrench 24 mm [TS180(C)]	

Model	ES50 (C) TS50 (C)	ES60(C) TS60(C)	ES70(C) TS70(C)	ES80(C) TS80(C)	ES105(C) TS105(C)	ES130(C) TS130(C)	ES155(C) TS155(C)	TS180(C)
Tightening torque kg-m	9.7	9.7	12.5	12.5	12.5	13.65	20.0	20.0

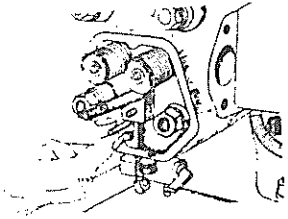
Oil pipe	1	(2) Connect the oil pipe.		Wrench 13 mm	
Push rod	1	(3) Insert the push rods. Note: Make sure that the push rods enter the tappet holes correctly.		Wrench 17 mm	

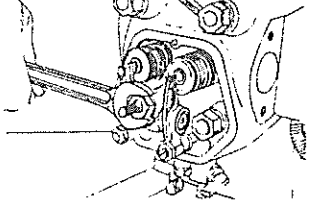
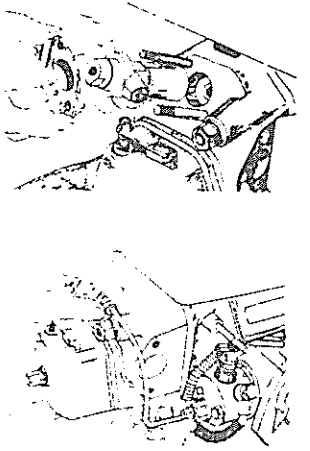
Item	Q'ty	Procedure & cautions	Model	Tools	Figure
Intake-exhaust rocker arm	1	<p>(4) Install the intake-exhaust rocker arm assembly.</p> <p>Note: Make sure that the push rods do not slip out of place.</p>		<p>Wrench 17 mm</p> <p>Wrench 19 mm [TS180(C)]</p>	
Rocker arm case	1	<p>(5) Install the rocker arm case.</p> <p>Make sure that the packing does not bend.</p>		<p>Wrench 13 mm</p> <p>Philips screwdriver</p> <p>Wrench 10 mm [TS180(C)]</p>	
17. Fuel injection nozzle	1	<p>(1) Install the front part of the antichamber.</p> <p>Note: Make sure that the copper packing is in place.</p> <p>(2) Insert the rear part of the antichamber.</p> <p>Note: Make sure that the copper packing is in place.</p> <p>(3) Insert the fuel injection nozzle.</p> <p>(4) Temporarily fit the fuel injection pipe to the fuel injection nozzle.</p>	Whole	<p>Wrench 13 mm</p>	

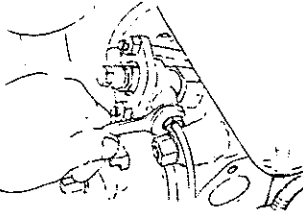
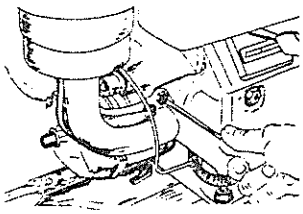
Item	Q'ty	Procedure & cautions	Model	Tools	Figure
		<p>(5) Temporarily fit the fuel return pipe to the fuel injection nozzle.</p> <p>(6) Tighten the fuel injection nozzle retainer.</p> <p>(7) Tighten the fuel injection pipe and fuel return pipe.</p>		<p>Wrench 13 mm</p> <p>Wrench 13 mm</p> <p>Wrench 19 mm [TS180(C)]</p> <p>Wrench 13 mm</p>	
8.	Side cover	(1) Install the side cover.	Whole	<p>Philips screwdriver</p> <p>Wrench 13 mm</p>	
9.	Exhaust silencer	(1) Install the exhaust silencer and gasket packing.		<p>Wrench 13 mm</p> <p>Philips screwdriver</p>	
10.	Air cleaner	<p>(1) Install the air cleaner.</p> <p>(2) Install the fuel injection pipe center rest.</p>		<p>Wrench 13 mm</p> <p>Philips screwdriver</p> <p>Wrench 17 mm [TS180(C)]</p>	

8. DISASSEMBLY AND REASSEMBLY OF MAJOR COMPONENTS

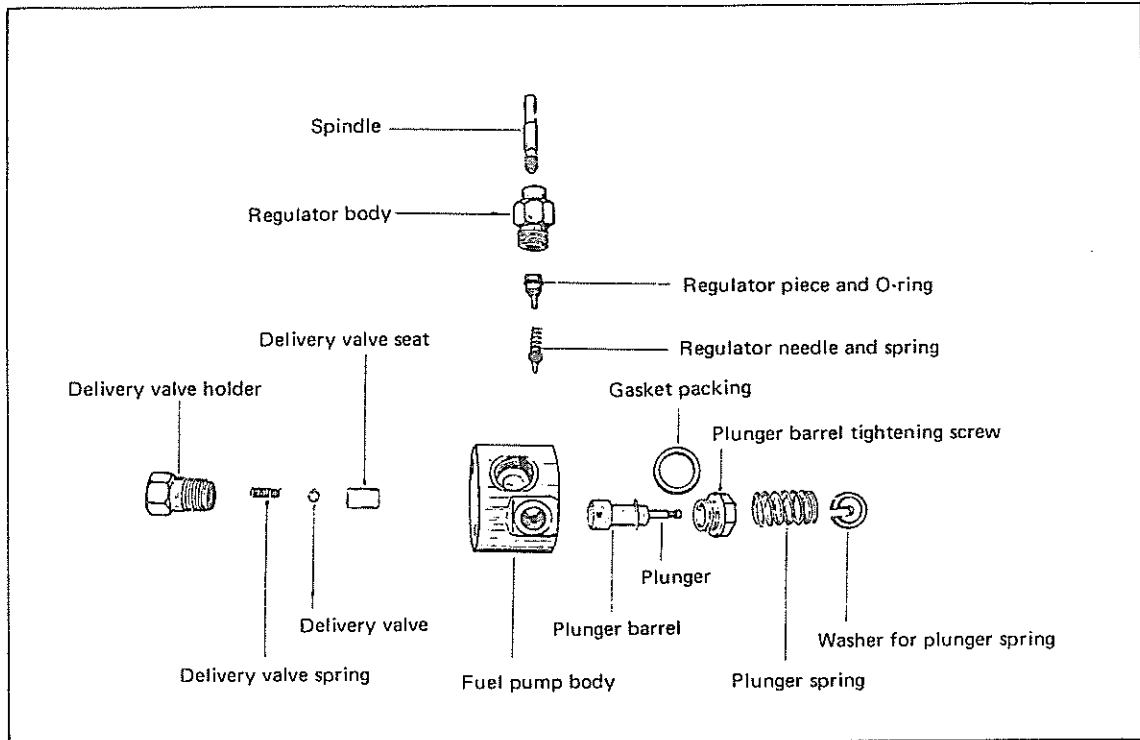

1) FUEL INJECTION PUMP (Deckel type) ES50 (C) ~ ES155 (C) TS50 (C) ~ TS155 (C)

(fuel injection pump components)

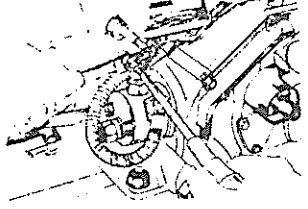
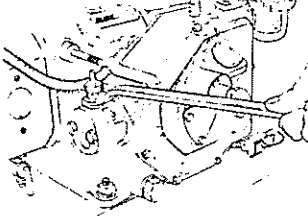

1) Disassembly

Item	Q'ty	Procedure & cautions	Model	Tools	Figure
1. Fuel injection pipe	1	(1) Disconnect the fuel injection pipe. Note: Removing the air cleaner beforehand makes the work easier.	ES50(C) -ES155(C) TS50(C) -TS155(C)	Wrench 13 mm Philips screw- driver	
2. Delivery valve	1	(1) Make sure that the fuel cock is closed and remove the delivery valve holder. Note: Do not lose the delivery valve and delivery valve spring.			

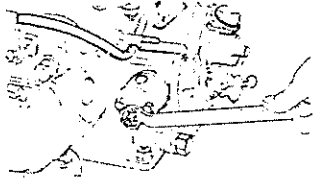
Item	Q'ty	Procedure & cautions	Model	Tools	Figure
3.	1	(1) Remove the pump adjustment lever link screw and separate the adjustment lever.	ES50(C) -ES155(C) TS50(C) -TS155(C)	Philips screw-driver Wrench 10 mm	
4.	1	(1) Remove the regulator body. Note: Do not lose the regulator needle.		Box-end wrench 19 mm	
5.	1	(1) Disconnect the fuel pipe at the injection pump.		Wrench 17 mm	
		(2) Remove the fuel injection pump body.		Wrench 13 mm	
6.		(1) Install the pump body in reverse and remove the plunger barrel screw. Note: Work with the plunger inserted.		Box-end wrench 19 mm	

2) Reassembly

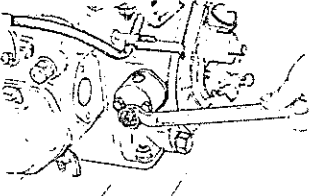
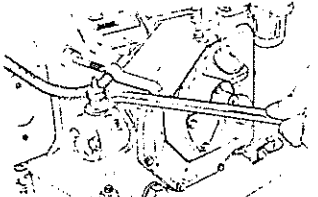
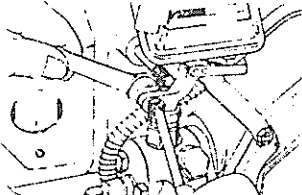
Item	Q'ty	Procedure & cautions	Model	Tools	Figure
1.	Plunger barrel	<p>(1) Thread in and tighten the plunger barrel screw. Note: Use new packing. Work with the plunger inserted. Tightening torque: 7 kg-m</p>	ES50(C) -ES155(C) TS50(C) -TS155(C)	Box-end wrench 19 mm Torque wrench	
2.	Fuel injection pump body	<p>(1) Install the fuel injection pump body. Note: Make sure that the plunger spring seat is positioned correctly.</p>		Box wrench 13 mm	
3.	Regulator body	<p>(1) Install the regulator body. Note: Tighten while making sure that the regulator spindle remains free.</p>		Box-end wrench 19 mm	
4.	Pump adjustment lever	<p>(1) Fit the pump adjustment lever to the regulator spindle.</p> <p>(2) Temporarily tighten the pump adjustment lever link screw.</p> <p>(3) Adjust the governor lever.</p>		Philips screw-driver Wrench 10 mm	

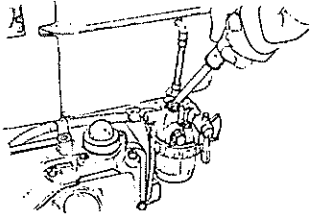
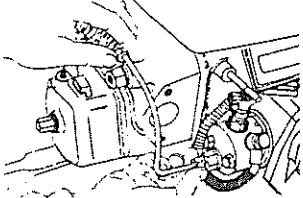
	Item	Q'ty	Procedure & cautions	Model	Tools	Figure
5.	Fuel pipe		(1) Connect the fuel pump end of the fuel pipe.	ES50(C) -ES155(C) TS50(C) -TS155(C)	Wrench 17 mm	
6.	Delivery valve		(1) Bleed air at the fuel outlet strainer. Install the delivery valve holder.			
7.	Fuel injection pipe		(1) Connect the fuel injection pipe to the fuel injection pump. After bleeding air, connect the fuel injection nozzle end and check injection.			

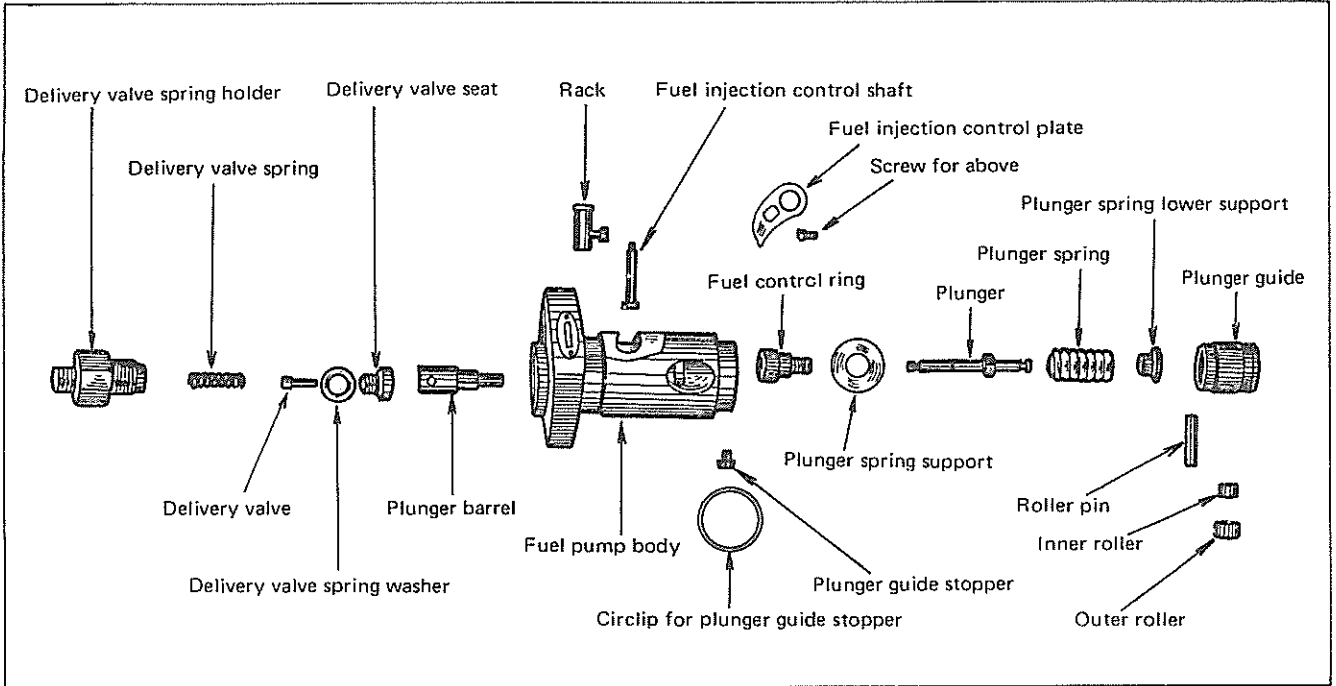

(fuel injection pump components)

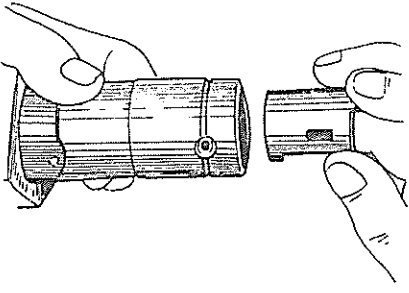
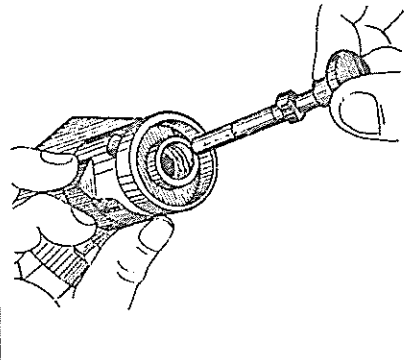
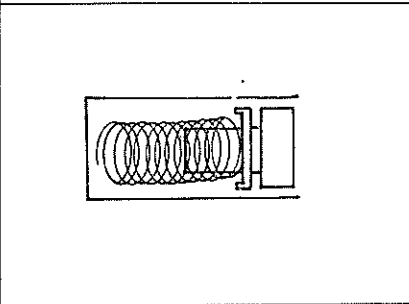
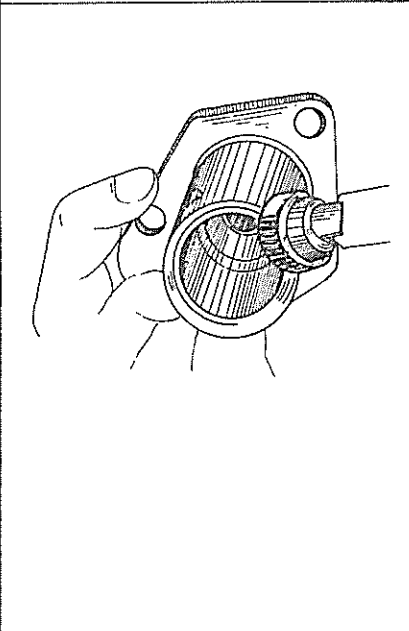

1) Disassembly

Item	Q'ty	Procedure & cautions	Model	Tools	Figure
1 Plunger guide	1	(1) Remove the snap ring of the plunger guide stopper.	TS180(C)	Flat screwdriver	
		(2) Remove the plunger guide stopper. Note: Force down while hold the plunger guide.			

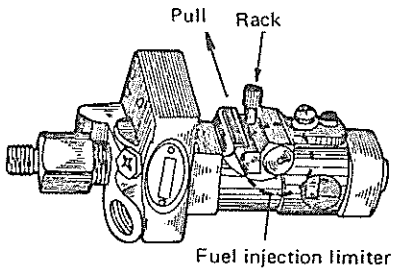
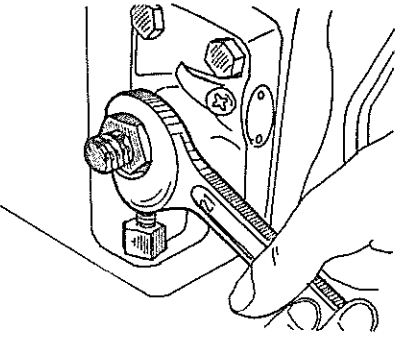
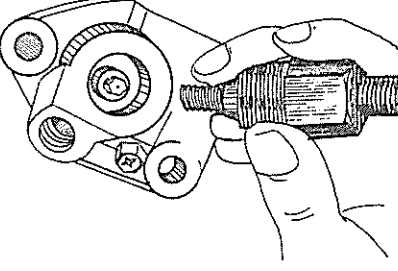
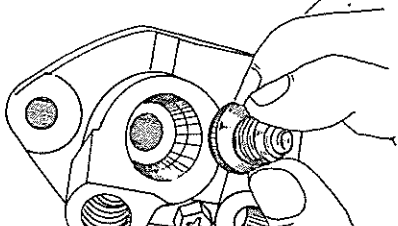
Item	Q'ty	Procedure & cautions	Model	Tools	Figure
		<p>(3) Pull out the plunger guide. Note: Together with roller assembly.</p> <p>(4) Remove the roller.</p>	TS180(C)		
2	Plunger	<p>(1) Extract the plunger. Note: Remove the plunger spring lower support at the same time.</p> <p>(2) Remove the plunger spring and the top plunger spring support</p> <p>(3) Remove the rack drive pinion.</p>			  

Item	Q'ty	Procedure & cautions	Model	Tools	Figure
		<p>(4) Remove the rack. Note: The fuel injection limiter has been adjusted at the factory. Avoid removing it, as removal is unnecessary in the work described here.</p>	TS180(C)		
3	1	<p>(1) Remove the delivery valve spring holder.</p>		Wrench 21 mm	
		<p>(2) Remove the delivery valve spring.</p> <p>(3) Remove the delivery valve.</p>			
Plunger barrel		<p>(4) Remove the plunger barrel by driving it out from the bottom.</p>			
Delivery valve seat		<p>(5) Remove the delivery valve seat at the same time.</p>			

2) Reassembly

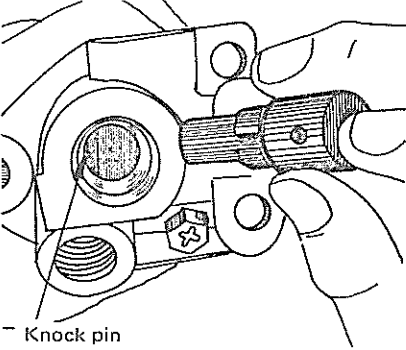
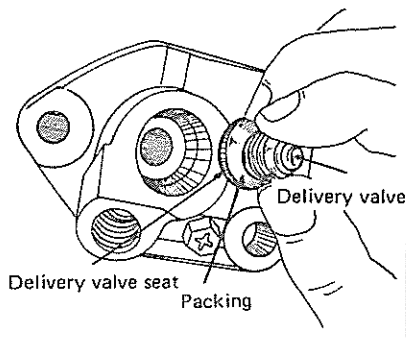
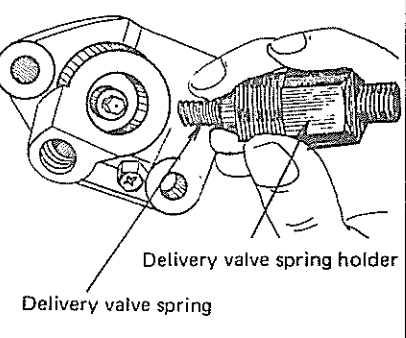
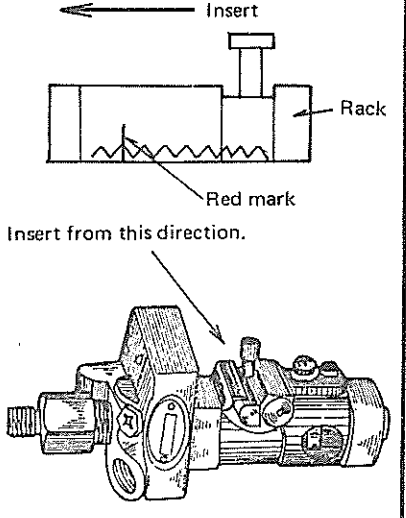
Item	Q'ty	Procedure & cautions	Model	Tools	Figure
1 Plunger barrel	1	(1) Insert the plunger barrel. Note: Align the pump body Knock pin and cut-away of the plunger barrel.	TS180(C)		 <p>Knock pin</p>
2 Delivery valve	1	(1) Insert the delivery valve seat and delivery valve assembly. Note: Fit the packing into place at the same time.			 <p>Delivery valve seat Packing</p>
		(2) Insert the delivery valve spring. Note: Align the spring with the delivery valve. (3) Install the delivery valve spring holder.		Wrench 21 mm	 <p>Delivery valve spring holder Delivery valve spring</p>
3 Rack	1	(1) Insert the rack. Note: Make sure that the red mark is on the plunger guide side.			 <p>Insert Rack Red mark Insert from this direction.</p>

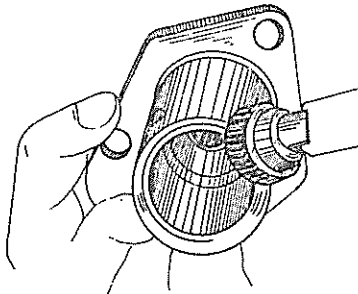
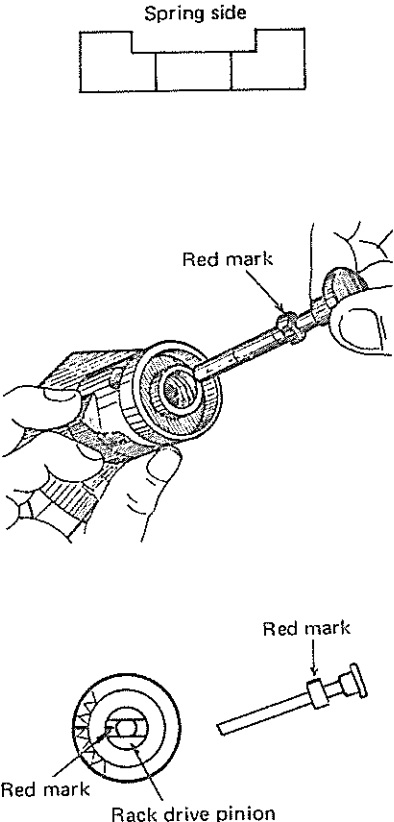
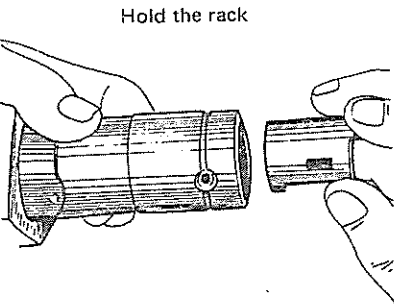
Item	Q'ty	Procedure & cautions	Model	Tools	Figure
4	1	<p>(1) Insert the rack drive pinion.</p> <p>Note: Place the red mark of the rack at the center of the pump body.</p> <p>Insert your index finger into the cutaway of the pinion and align the mark.</p>	TS180(C)		
5	1	<p>(1) Insert the top plunger spring support.</p> <p>Note: Pay attention to positioning, placing the indented part toward the plunger spring.</p> <p>(2) Insert the plunger spring.</p> <p>(3) Insert the plunger.</p> <p>Note: Align the red mark of the plunger and cutaway of rack drive pinion and insert the plunger.</p> <p>After setting plunger spring lower support to the plunger, insert the plunger.</p>			
6	1	<p>(1) Insert the plunger guide.</p> <p>Note: Hold the rack so that the plunger cannot move. Align the plunger guide stopper and the pump body stoppor.</p>			

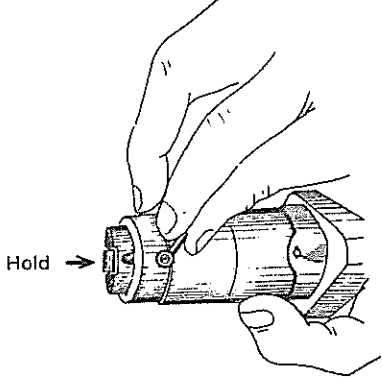
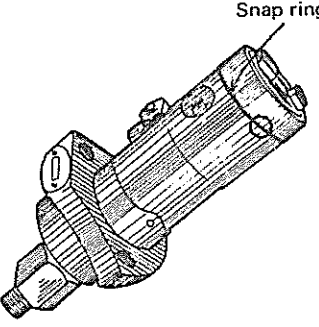
Item	Q'ty	Procedure & cautions	Model	Tools	Figure
		<p>(2) Insert the plunger guide stopper. Note: Hold the roller and insert the stopper.</p>	TS180(C)		
		<p>(3) Fit the snap ring to the plunger guide stopper.</p>			

2) FUEL INJECTION VALVE

Components

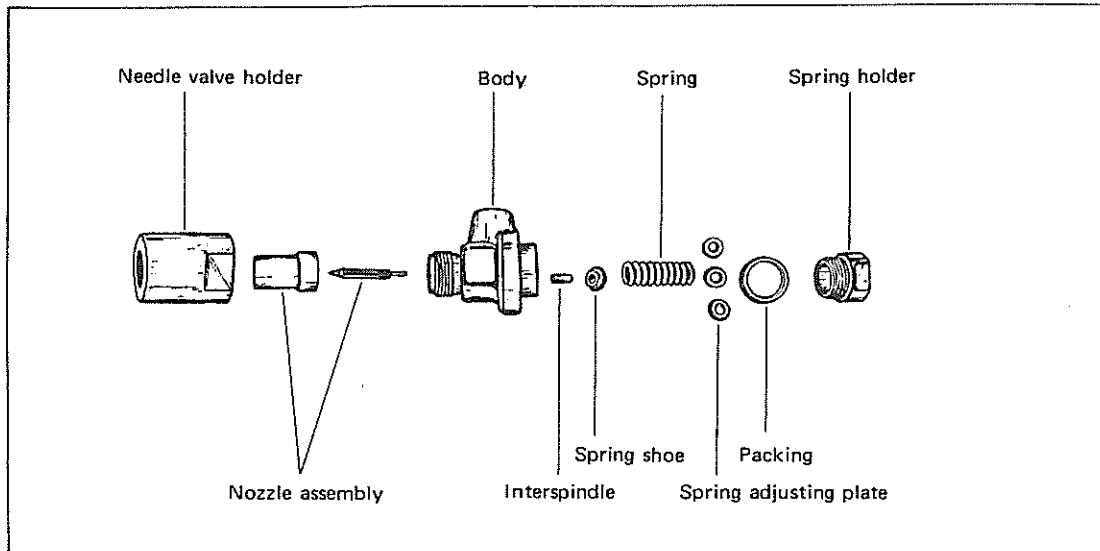

1) Disassembly

	Procedure and Cautions	Tools	Figure
1.	(1) Disconnect the fuel injection and return pipes.	Wrench 13 mm Wrench 14 mm } TS180 Wrench 19 mm } (C)	
	(2) Remove the mounting nuts and detach the fuel injection valve holder.	Wrench 13 mm Wrench 19 mm TS180(C)	

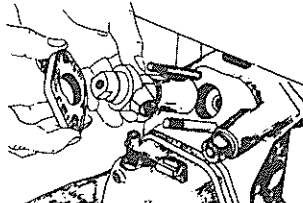
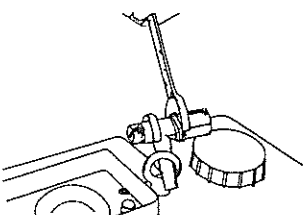
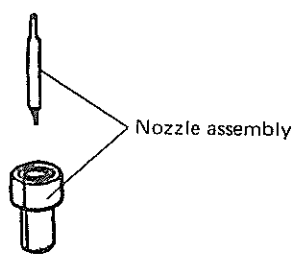
Procedure and Cautions	Tools	Figure
<p>(3) Remove the fuel injection valve.</p>		
<p>2. (1) Attach the nozzle body puller to the fuel injection valve.</p> <p>(2) Insert the end of the nozzle body puller in the engine suspension eye nut and loosen the nozzle mounting nut and nozzle spring chamber.</p> <p>Note: Proceed carefully to avoid damaging the hopper and hopper core.</p>	<p>Nozzle body puller</p> <p>Wrench 24 mm</p>	
<p>3. (1) Remove the nozzle mounting nut.</p> <p>(2) Separate the nozzle from the nozzle mounting nut.</p> <p>(3) Separate the nozzle valve from the nozzle body. Make sure that the nozzle seat is clean and serviceable, that there is no sign of discoloration, burning, or wear. Wash the nozzle valve and return it to the nozzle body.</p>		

Procedure and Cautions	Tools	Figure
<p>4. (1) Remove the nozzle spring holder. Note: Note the number and thickness of the nozzle spring adjusting plate.</p> <p>(2) Remove the nozzle spring.</p> <p>(3) Remove the nozzle spring shoe. Note: Exercise care to avoid losing the nozzle spring holder.</p> <ul style="list-style-type: none"> ● Note the direction of the protruding portion. <p>(4) Remove the interspindle. Note: Take care not to lose.</p> <ul style="list-style-type: none"> ● Note the sequence of the parts assembly. 	<p>Wrench 17 mm</p>	

2) Reassembly

Procedure and Cautions	Tools	Figure
<p>1. (1) Fit the nozzle valve and nozzle body to the needle valve holder. Note: Wash the nozzle valve and nozzle body in clean fuel and coat them with oil.</p>		

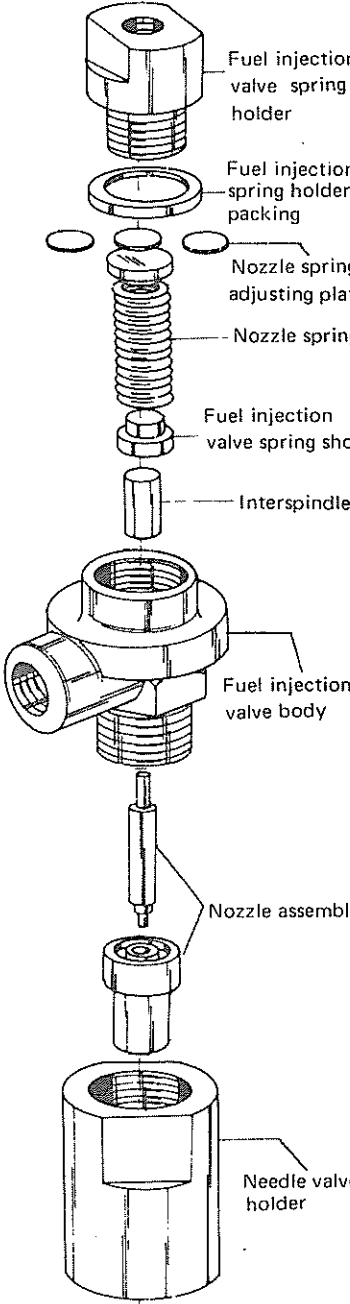
Procedure and Cautions	Tools	Figure
<p>(2) Temporarily fit the needle valve holder to the valve body.</p> <p>(3) Insert the interspindle in the valve body.</p> <p>(4) Fit the valve spring shoe and nozzle spring to the valve body. Note: Fit the protruding end of the valve spring shoe into the nozzle spring. Turn the valve body on its side, to keep parts from falling out.</p> <p>(5) Place the nozzle spring adjusting plate in the valve spring holder.</p> <p>(6) Temporarily secure the valve spring holder.</p> <p>(7) Attach the nozzle body puller to the fuel injection valve.</p>	<p>Nozzle body puller</p>	

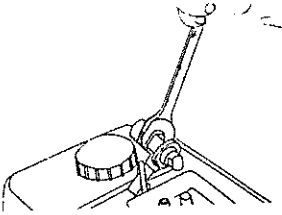
Procedure and Cautions	Tools	Figure
<p>(8) Insert the nozzle body puller in the engine suspension eyenut.</p> <p>(9) Firmly secure the needle valve holder and valve spring holder.</p> <p>(10) Detach the nozzle body puller.</p>	<p>Wrench 24 mm Wrench 17 mm</p>	
<p>2. Fuel Injection Tests</p> <p>(1) Attach the fuel injection pipe to the fuel injection pump.</p> <p>(2) Temporarily attach the fuel injection valve to the fuel injection pipe. Note: Place the arrow of the fuel injection valve toward the fuel injection pipe.</p> <p>(3) Turn the flywheel to force air from the fuel injection pipe.</p> <p>TS180(C)</p> <p>Using the priming handle, bleed air from the fuel injection pipe. Note: Align the flywheel to the point at which priming causes the pump to operate.</p>	<p>Wrench 13 mm Wrench 19 mm TS180(C)</p> <p>Wrench 13 mm Wrench 14 mm TS180(C)</p>	

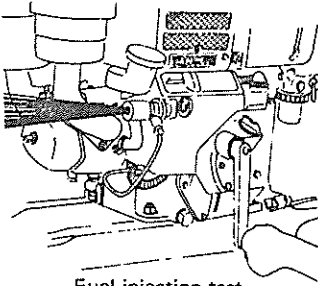
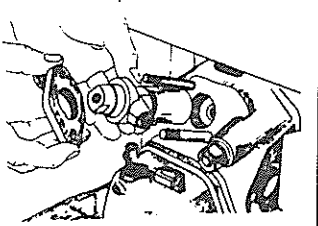
Procedure and Cautions	Tools	Figure
<p>(4) Secure the fuel injection pipe (fuel injection nozzle end).</p> <p>(5) Continue turning the flywheel until fuel comes from the nozzle. Note the state of ejection.</p> <p>TS180(C) Continue priming until fuel begins to flow from the fuel injection valve.</p>	<p>Wrench 13 mm Wrench 14 mm TS180(C)</p>	 <p>Fuel injection test</p>
<p>3. Installing Fuel Injection Nozzle</p> <p>(1) If the state of fuel ejection is normal, remove the fuel injection nozzle and fuel injection pipe.</p> <p>(2) Remove the fuel injection nozzle and fuel injection pipe.</p> <p>(3) Fit the fuel injection nozzle to the cylinder head.</p> <p>(4) Fit the fuel injection valve holder into place and temporarily tighten the nut.</p>	<p>Wrench 13 mm Wrench 14 mm } TS180 Wrench 19 mm } (C)</p> <p>Wrench 13 mm Wrench 14 mm } TS180 Wrench 19 mm } (C)</p> <p>Wrench 13 mm Wrench 19 mm } TS180 (C)</p>	

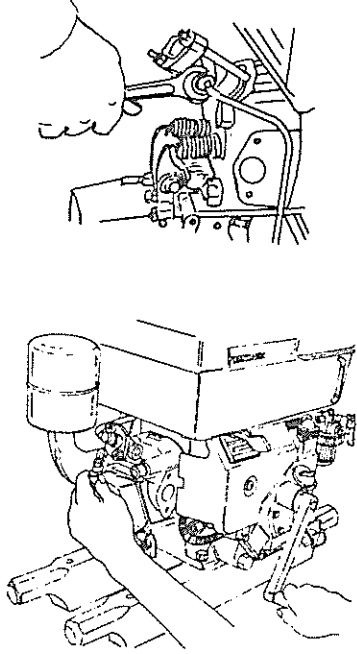
Procedure and Cautions	Tools	Figure
<p>(5) Temporarily secure the fuel injection pipe and fuel return pipe.</p> <p>(6) Secure the fuel injection valve holder, then the fuel injection and fuel return pipes.</p> <p>(7) Turn the engine by hand, confirming that fuel is injected.</p> <p>TS180(C) Prime and ascertain whether or not fuel is being injected.</p>	<p>Wrench 13 mm Wrench 14 mm TS180 (C)</p> <p>Wrench 13 mm Wrench 14 mm Wrench 19 mm</p>	

9. ADJUSTMENT OF PRINCIPAL COMPONENTS

1) INTAKE, EXHAUST VALVE CLEARANCE

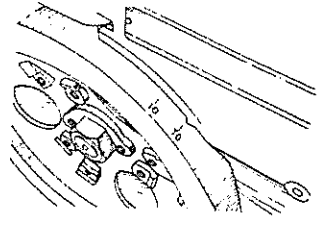
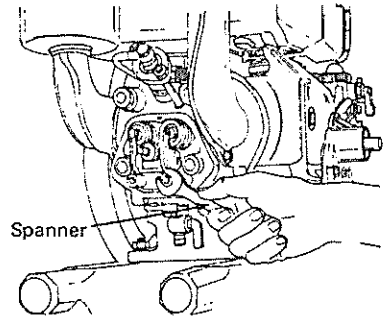
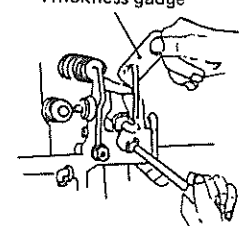
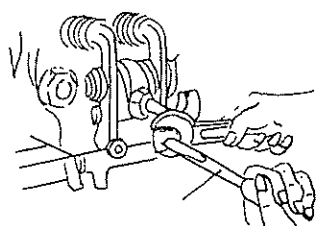
Procedure	Tools	Figure
<p>Preparation</p> <p>1. Bring the piston to top dead center on the compression stroke by turning the flywheel.</p>	<p>(1) Turn the flywheel in the direction of normal rotation.</p> <p>(2) When compression (resistance) is felt, release the decompression lever by moving it to the left.</p> <p>(3) Move the decompression lever still another quarter turn in the same direction.</p> <p>(4) Align the TD mark of the flywheel and the arrow of the hopper.</p> <p>(5) Return the decompression lever to its original position.</p>	
<p>2. Loosen the valve clearance adjusting screw nut.</p>	<p>Wrench 13 mm Wrench 17 mm</p>	 <p>Spanner</p>
<p>Adjustment</p> <p>3. Adjust clearance to 0.2 mm by turning the valve clearance adjusting screw.</p>	<p>Thickness gauge</p>	 <p>Thickness gauge</p>
<p>4. Retighten the valve adjusting screw nut.</p>	<p>Flat screwdriver Wrench 13 mm</p> <p>Wrench 17 mm TS180(C)</p>	

Procedure		Tools	Figure
5. Using the thickness gauge, recheck the clearance.	As before, the thickness gauge must slip in and out freely.	Thickness gauge	

2) GOVERNOR LINKAGE ADJUSTMENT *ES50 (C) ~ ES155 (C) TS50 (C) ~ TS155(C)*

The governor system resembles the human nervous system. It monitors the engine load and subsequently controls the fuel pump, feeding the amount of fuel required to maintain the engine at a stable speed. When the engine speed changes because of a load change, the position of the governor flyweights changes accordingly. This change is transmitted to governor linkage, operating the fuel pump regulator and the coupled needle valve. In this manner, the amount of fuel fed is automatically controlled. Improper adjustment of the governor linkage will adversely affect the action transferred from the flyweights to the fuel pump. As a result, poor speed regulation, low engine output, and starting difficulties will occur.

There are two adjustment procedures: 'Assembly' and 'link'. The first is a little complicated, although the latter is quite simple. The user should be instructed in adjustment accordingly. (After extended operation, the injection noise becomes less pronounced, the engine is sluggish, and engine output is low. These conditions indicate that it is time for governor adjustment.)

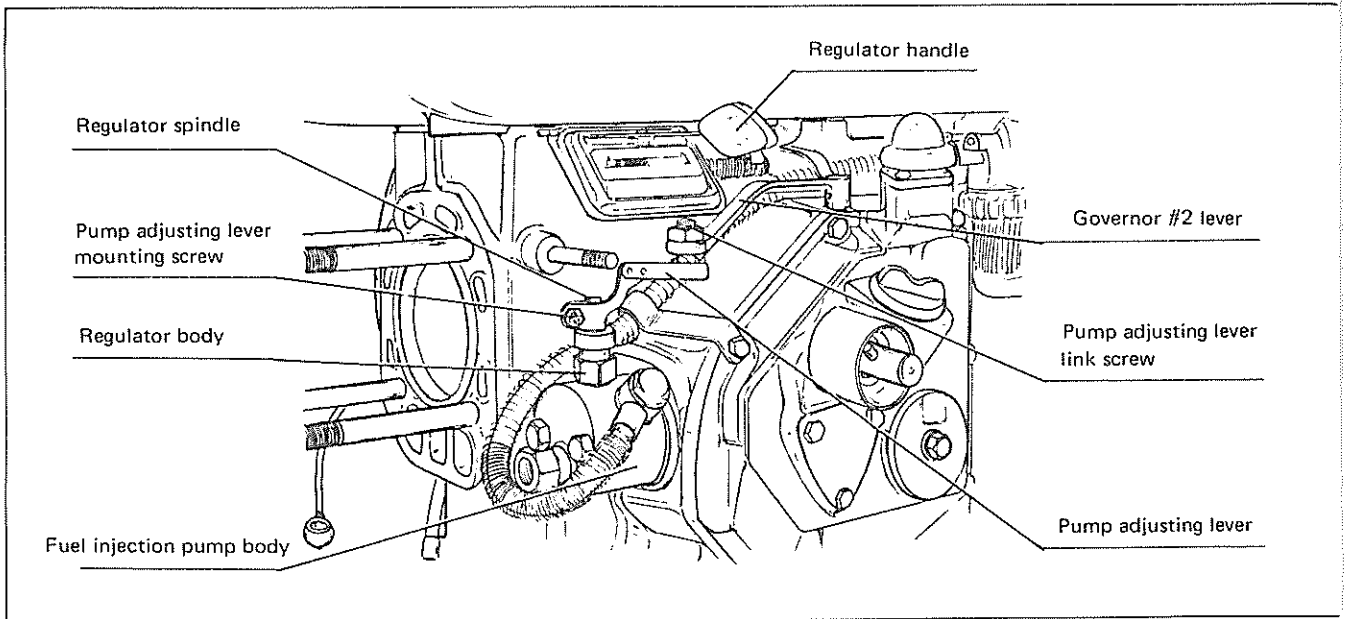

ADJUSTMENT PROCEDURE (#1) 'Assembly Method'

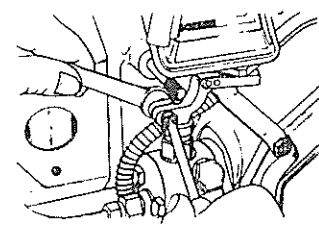
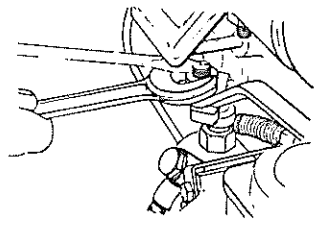
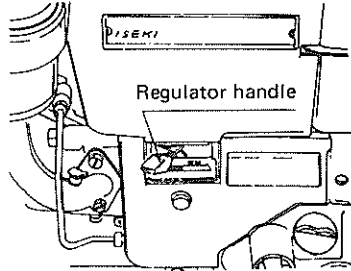
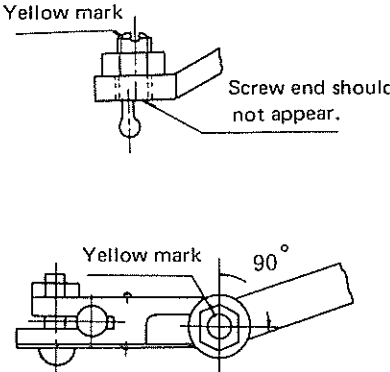
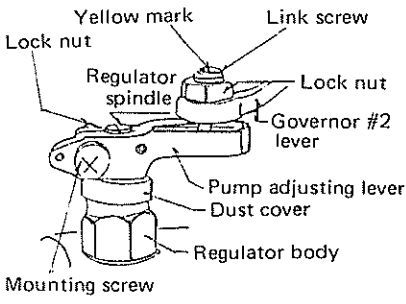
Procedure	Tools	Figure
<p>Preparation</p> <p>1. Loosen the pump adjusting lever mounting screw.</p>	<p>(1) Loosen the pump adjusting lever mounting screw lock nut.</p> <p>(2) Loosen the mounting screw.</p> <p>(3) Determine whether or not the pump adjusting lever and regulator spindle are free.</p>	<p>Wrench 10 mm</p> <p>Philips screwdriver</p> 
<p>2. Loosen the link screw lock nut.</p>	<p>Loosen the link screw lock nut. (The link screw need not be separated from the governor #2 lever.)</p>	<p>Wrench 17 mm</p> 
<p>3. Set the regulator handle to the starting position.</p>		
<p>Adjustment</p> <p>4. Set the link screw and direction of the yellow mark.</p>	<p>(1) Turn the link screw so that its bottom end is flush with the bottom surface of the governor #2 lever.</p> <p>(2) Point the yellow mark to the cylinder side, and make square between the pump adjusting lever and the mark.</p>	<p>Flat screwdriver or other suitable 'tool'</p> <p>Yellow mark</p> <p>Screw end should not appear.</p> 
<p>5. Thread in the regulator spindle.</p>	<p>(1) Thread in the regulator spindle by a small amount. (clockwise)</p> <p>(2) Turn the flywheel, confirming that injection noise can be heard.</p>	<p>Flat screwdriver or other suitable 'tool'</p> <p>Yellow mark</p> <p>Link screw</p> <p>Lock nut</p> <p>Regulator spindle</p> <p>Lock nut</p> <p>Governor #2 lever</p> <p>Pump adjusting lever</p> <p>Dust cover</p> <p>Regulator body</p> <p>Mounting screw</p> 

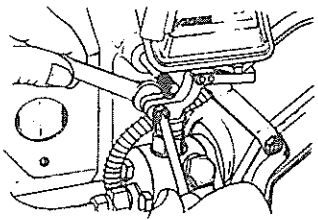
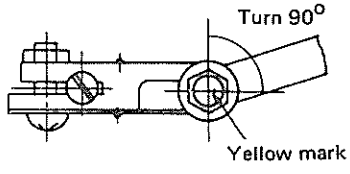
Procedure		Tools	Figure
6. Secure the pump adjusting lever mounting screw with the lock nut.	<p>(1) Using one hand to hold the pump adjusting lever so that it cannot move, tighten the mounting screw with a philips screwdriver.</p> <p>(2) While holding the mounting screw with the screwdriver so that it cannot turn, the lock nut can be tightened. There is no need of holding the pump adjusting lever.</p>	<p>Philips screwdriver</p> <p>Flat screwdriver or other suitable 'tool'</p>	
7. Turn the link screw 90° and secure it with the lock nut.	(1) Turn the link screw 90° to the right, so that the yellow mark is parallel with the pump adjusting lever.	Flat screwdriver or other suitable 'tool'	

ADJUSTMENT PROCEDURE (#2) 'Link Screw Method'

With this method, there is no need to loosen the pump adjusting lever mounting screw. Instead, the link screw is turned 90° as shown in the following figure.

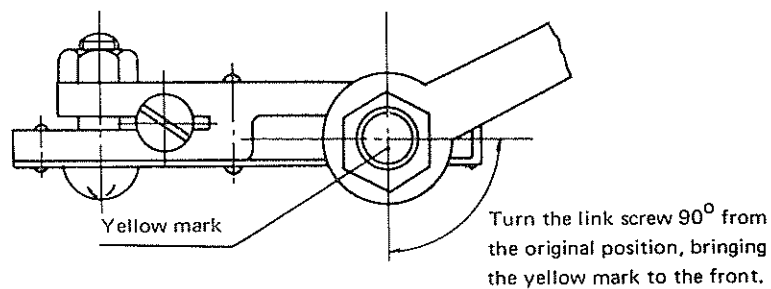

Procedure		Tools	Figure
Preparation		Wrench 17 mm	
1. Loosen the link screw lock nut.			
Adjustment		Flat screwdriver or other suitable 'tool'	
2. Turn the link screw 90°	Bring the yellow mark to the front, as indicated in the figure.		
3. Secure the link screw with the lock nut.		Wrench 17 mm	

TS180 (C)

There are some differences in governor system between TS50 ~ 150 and TS180. Followings are adjustment procedure for TS180(C).

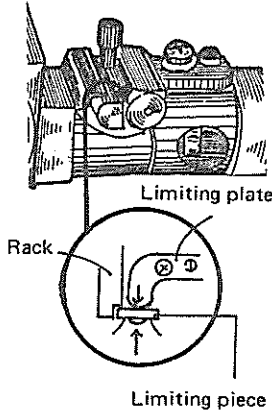
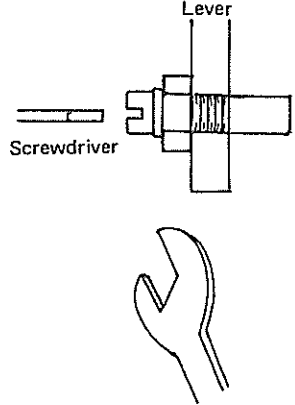
	Procedure	Tools	Figure
<p>Preparation</p> <p>1. Remove the cylinder side cover.</p>		<p>Philips screwdriver Wrench 13 mm</p>	
<p>2. Loosen the governor adjusting bolt.</p>	<p>Loosen the governor adjusting bolt lock nut, freeing the governor adjusting bolt.</p>	<p>Wrench 13 mm</p>	
<p>Adjustment</p> <p>3. Set the gap between the governor adjusting bolt and governor spindle to 2 mm.</p>  <p>Limiting plate</p> <p>Rack</p> <p>Limiting piece</p>	<p>Close down the gap to the point at which the thickness gauge can still slip in and out and tighten the lock nut.</p> <p>Lock nut tightening torque</p> <p>Note: Move the governor lever to the forward position. Hold the fuel pump rack against the limiting piece, so that it cannot move. Measure clearance at the end of the governor spindle.</p>	<p>Thickness gauge Flat screwdriver Wrench 13 mm</p>	 <p>Lever</p> <p>Screwdriver</p>

10. DISASSEMBLY AND REASSEMBLY OF MODELS ES(C) & TS(C) CONDENSERS

1) DISASSEMBLY

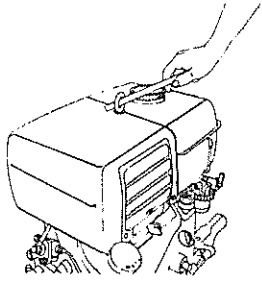
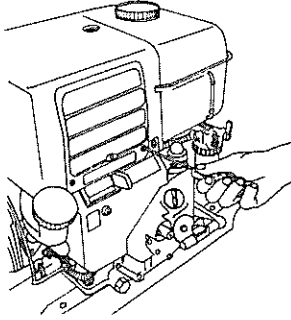
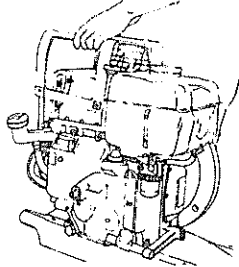
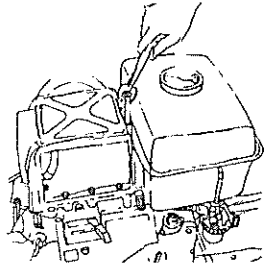
Procedure and Cautions	Tools	Figure
1. Remove the air cleaner.	Philips screwdriver Wrench 13 mm Wrench 17 mm	
2. Remove the exhaust silencer.	Philips screwdriver Wrench 13 mm	
3. Remove the eyebolt.	Steel tube or bar.	
4. Remove the condenser screen.	Philips screwdriver	
5. Remove the condenser cover mounting screws. 6. Remove the condenser cover.	Philips screwdriver	
7. Remove the eyebolt nut.	Wrench 17 mm	

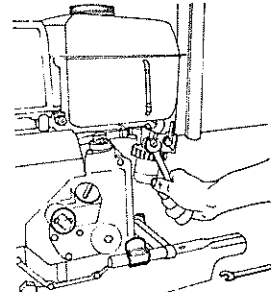
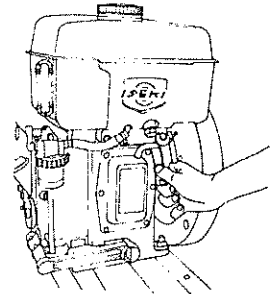
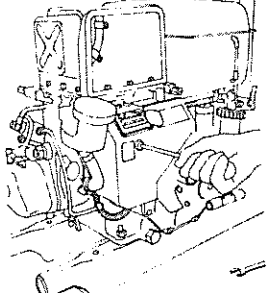
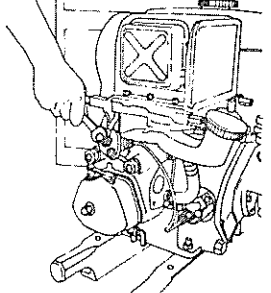
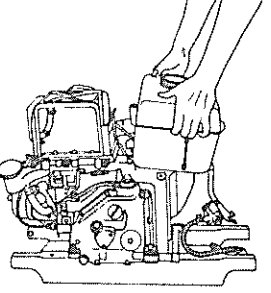
Procedure and Cautions	Tools	Figure
8. Remove the fuel strainer.	Wrench 13 mm	
9. Remove the fuel tank mounting bolts.	Wrench 13 mm Wrench 17 mm	
10. Remove the side cover and the fuel pipe mounting bolt.	Philips screwdriver Wrench 17 mm	
1. Remove the fuel return pipe joint bolt and disconnect the fuel return pipe.	Wrench 13 mm	
2. Remove the fuel tank.		

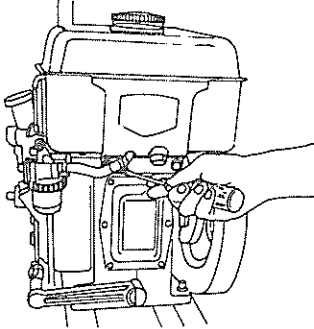
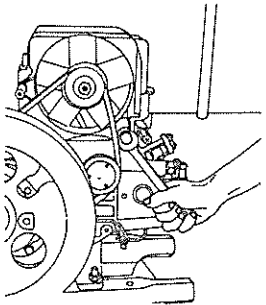
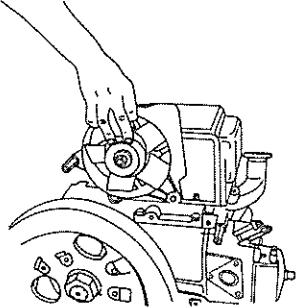
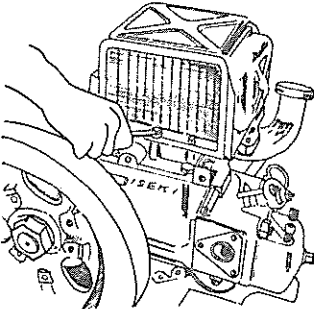
Procedure and Cautions	Tools	Figure
<p>13. When the fuel tank is empty, unfasten the hose bands and remove the fuel tank. (That is, steps (9) and (10) are unnecessary.)</p>	Flat screwdriver	
<p>14. Remove the tension pulley mounting bolt and the V-belt for the cooling fan.</p>	Wrench 17 mm	
<p>15. Remove the cooling fan.</p>	Wrench 17 mm	
<p>16. Remove the condenser mounting bolts and detach the condenser.</p>	Wrench 10 mm	

Procedure and Cautions

Tools

Figure

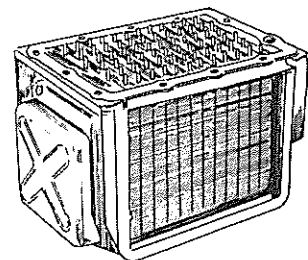
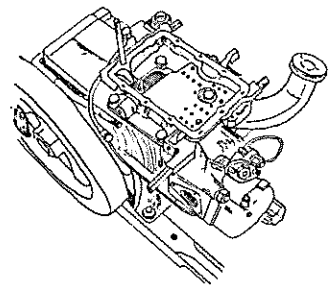
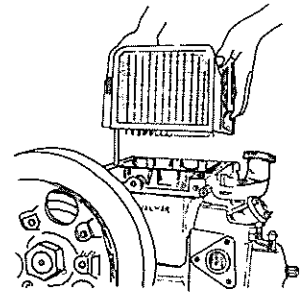

2) REASSEMBLY

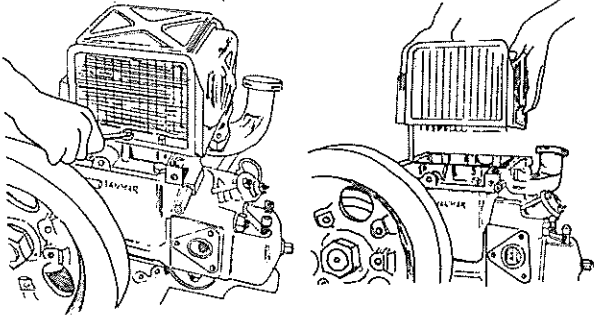
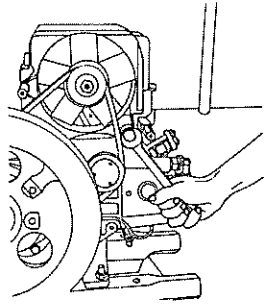
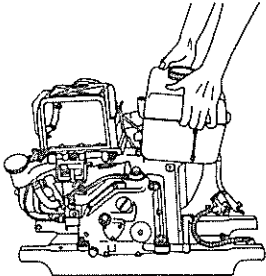
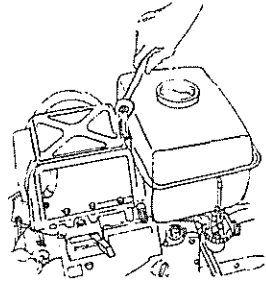
Procedure and Cautions	Tools	Figure
<p>1. Install the condenser and tighten the mounting bolts. Remove any dirt in the fins.</p>	<p>Wrench 10 mm</p>	
<p>2. Install the cooling fan and the drive V-belt. Install the tension pulley and adjust belt tension.</p>	<p>Wrench 17 mm</p>	
<p>3. Install the fuel tank.</p>		
<p>4. Tighten the eyebolt nut.</p>	<p>Wrench 17 mm</p>	

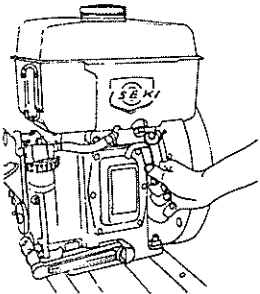
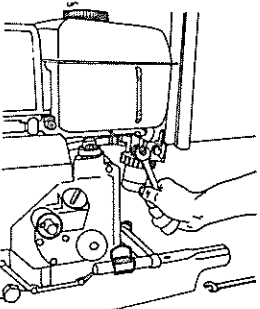
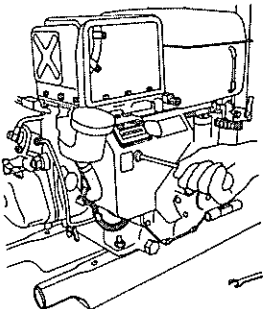
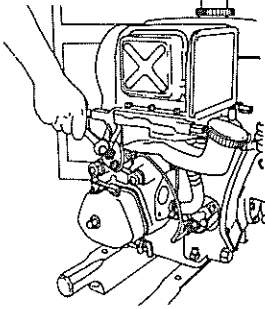
Procedure and Cautions	Tools	Figure
i. Tighten the fuel tank mounting bolts.	Wrench 13 mm	
. Install the fuel strainer.	Wrench 13 mm	
Tighten the fuel pipe mounting bolt and install the side cover.	Philips screwdriver Wrench 17 mm	
Install the fuel return pipe.	Wrench 13 mm	

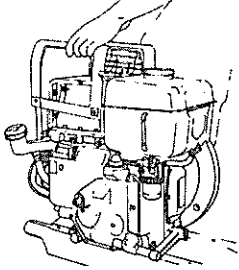
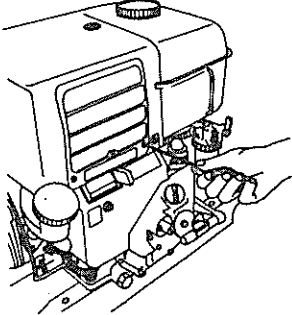
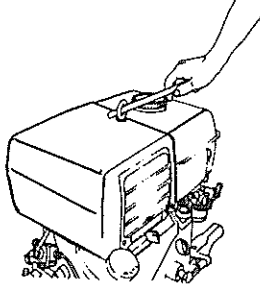
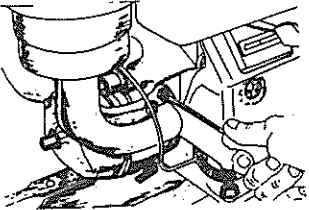
Procedure and Cautions	Tools	Figure
9. Install the condenser cover.		
10. Install the condenser screen. (Remove any dirt from the screen.)	Philips screwdriver	
11. Install the suspension eyebolt.	Steel tube or bar.	
12. Install the exhaust silencer.	Philips screwdriver Wrench 13 mm	
13. Install the air cleaner. Install the high-pressure pipe check.	Philips screwdriver Wrench 13 mm	

11. ADJUSTMENT STANDARD

Note: In case of being over limit of clearance, refer to the "wear limit" of each parts so that replace the parts much wore.

(mm)

Name of parts		Adjustment standard	ES50(C)/TS50(C)		ES60(C)/TS60(C)		ES70(C)/TS70(C)		ES80(C)/TS80(C)		ES105(C)/TS105(C)		ES130(C)/TS130(C)		ES155(C)/TS155(C)		TS180(C)		
			Nominal	Limit	Nominal	Limit	Nominal	Limit	Nominal	Limit	Nominal	Limit	Nominal	Limit	Nominal	Limit	Nominal	Limit	
Limit of clearance	Clearance between cylinder liner & piston	0.005d	0.113	0.350	0.109	0.375	0.110	0.400	0.110	0.440	0.208	0.425	0.158	0.460	0.181	0.475	0.173	0.510	
	Clearance between piston ring & groove	0.3	0.0375	0.3	0.0375	0.3	0.0375	0.3	0.0375	0.3	0.0375	0.3	0.0525	0.3	0.0695	0.3	0.0695	0.3	
	Clearance between piston pin & bush	0.0075d	0.036	0.158	0.036	0.173	0.0380	0.195	0.038	0.195	0.036	0.210	0.036	0.225	0.046	0.240	0.046	0.240	
	Clearance between crank pin & metal	0.004d	0.057	0.160	0.057	0.168	0.059	0.176	0.059	0.176	0.059	0.184	0.058	0.200	0.059	0.216	0.059	0.216	
	Clearance between crank journal & metal	0.004d	0.083	0.168	0.083	0.176	0.078	0.200	0.078	0.200	0.078	0.208	0.081	0.224	0.081	0.232	0.081	0.232	
	Clearance between suction/exhaust valve & valve guide	0.3	0.0525	0.3	0.0525	0.3	0.0525	0.3	0.0525	0.3	0.0525	0.3	0.0525	0.3	0.535	0.3	0.525	0.3	
Wear limit	Cylinder liner upper side, inner diameter	0.004D	70 ϕ	+0.280	75 ϕ	+0.300	80 ϕ	+0.320	80 ϕ	+0.320	85 ϕ	+0.340	92 ϕ	+0.368	95 ϕ	+0.380	102 ϕ	+0.420	
	Piston skirt, outer diameter	0.003d	70 ϕ	-0.210	75 ϕ	-0.225	80 ϕ	-0.240	80 ϕ	-0.240	85 ϕ	-0.255	92 ϕ	-0.276	95 ϕ	-0.285	102 ϕ	-0.306	
	Piston pin, outer diameter	0.005d	21 ϕ	-0.105	23 ϕ	-0.115	26 ϕ	-0.130	26 ϕ	-0.130	28 ϕ	-0.140	30 ϕ	-0.150	32 ϕ	-0.150	32 ϕ	-0.160	
	Piston pin metal, inner diameter	0.005D	21 ϕ	+0.105	23 ϕ	+0.115	26 ϕ	+0.150	26 ϕ	+0.130	28 ϕ	+0.140	30 ϕ	+0.150	32 ϕ	+0.160	32 ϕ	+0.160	
	Crankshaft, (pin) outer diameter	0.003d	40 ϕ	-0.120	42 ϕ	-0.126	44 ϕ	-0.132	44 ϕ	-0.132	46 ϕ	-0.138	50 ϕ	-0.150	54 ϕ	-0.162	54 ϕ	-0.162	
	Crankshaft, (journal) outer diameter	0.003d	42 ϕ	-0.126	44 ϕ	-0.132	50 ϕ	-0.150	50 ϕ	-0.150	52 ϕ	-0.156	56 ϕ	-0.168	58 ϕ	-0.174	58 ϕ	-0.174	
	Crank pin metal inner diameter	0.025D	40 ϕ	0.100	42 ϕ	0.105	44 ϕ	0.110	44 ϕ	0.110	46 ϕ	0.115	50 ϕ	0.125	54 ϕ	0.135	54 ϕ	0.135	
	Crank metal inner diameter	0.025D	42 ϕ	0.105	44 ϕ	0.110	50 ϕ	0.125	50 ϕ	0.125	52 ϕ	0.130	56 ϕ	0.140	58 ϕ	0.145	58 ϕ	0.145	
	First piston ring (chrome plated)	Width	0.15	2.0	0.15	2.0	0.15	2.5	0.15	2.5	0.15	2.5	0.15	2.5	0.15	2.5	0.15	2.5	0.15
		Thickness	0.1T	3.1	0.31	3.3	0.33	3.5	0.35	3.5	0.35	3.7	0.37	4	0.4	4.1	0.41	4.3	0.43
	2nd, 3rd piston ring	Width	0.15	2.0	0.15	2.0	0.15	2.5	0.15	2.5	0.15	2.5	0.15	2.5	0.15	2.5	0.15	2.5	0.15
		Thickness	0.1T	3.1	0.31	3.3	0.33	3.5	0.35	3.5	0.35	3.7	0.37	4	0.4	4.1	0.41	4.3	0.43
	Oil scraping ring	Width	0.15	4	0.15	4	0.15	4	0.15	4	0.15	4	0.15	4	0.15	4.5	0.15	4.5	0.15
		Thickness	0.1T	3.1	0.31	3.3	0.33	3.5	0.35	3.5	0.35	3.7	0.37	4	0.4	4.1	0.41	4.3	0.43
Ring ends gap	0.02D	0.3	0.14	0.3	0.15	0.4	0.16	0.4	0.16	0.4	0.17	0.4	0.184	0.4	0.19	0.4	0.204		





**Yvan Béal - 21, av. de l'Agriculture - B.P 16
Z.I. du Brézet - 63014 Clermont-Ferrand Cedex 2
Tél : 04 73 91 93 51 - Télécopie : 04 73 90 23 11
www.yvanbeal.fr - E-mail : info@yvanbeal.fr
R.C.S. B 304 973 886 - S.A.S. au capital de 612 000 €**