



intermotor

by  **LOMBARDINI**

SERIE **IM**

250 - 251 - 252
300 - 301 - 302
350 - 351 - 352

USO - MANUTENZIONE
RICAMBI

EMPLOI - ENTRETIEN
PIECES - DETACHEES

USE - MAINTENANCE
SPARE-PARTS

BEDIENUNG-WARTUNG
ERSATZTEILE

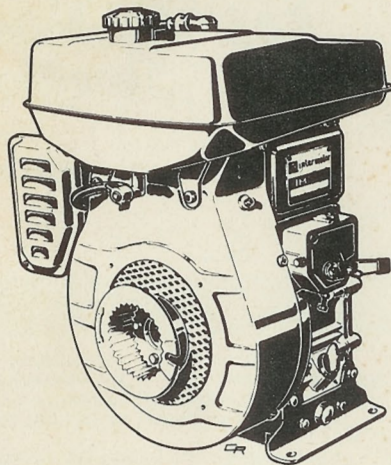

CARATTERISTICHE CHARACTERISTICS	CARACTERISTIQUES TECHNISCHE DATEN	250 251-252	300 301-302	350 351-352
ALESAGGIO - ALESAGE BORE - BOHRUNG	mm	70	76	82
CORSA - COURSE STROKE - HUB	mm	66	66	66
CILINDRATA - CYLINDREE DISPLACEMENT - HUBRAUM	cm ³	254	300	349
CICLO A SCOPPIO 4 TEMPI - CYCLE A EXPLOSION 4 TEMPS CYCLE: 4 STROKE SPARK IGNITION - ARBEITSVERFAHREN: VIERTAKT OTTOMOTOR				
ALIMENTAZIONE - ALIMENTATION FUEL - KRAFTSTOFF	250-251 BENZINA - ESSENCE 300-350 GASOLINE - BENZIN	252-302 PETROLIO - PETROLE 352 KEROSENE - PETROLEUM		
RAFFREDDAMENTO AD ARIA CON VOLANO VENTILATORE - REFROIDISSEMENT PAR AIR AVEC VOLANT VENTILATEUR AIR COOLED BY FLYWHEEL BLOWER - KÜHLUNG: LUFTGEKÜHLT MIT SCHWUNGRADGEBLASE				
ACCENSIONE CON ALTERNATORE AD ALTA TENSIONE - ALLUMAGE PAR ALTERNATEUR A HAUTE TENSION HIGH VOLTAGE ALTERNATOR IGNITION - ZÜNDUNG MIT HOCHSPANNUNGSGENERATOR				
LUBRIFICAZIONE FORZATA CENTRIFUGA - LUBRIFICATION FORCEE CENTRIFUGE FORCED CENTRIFUGAL LUBRICATION - ZENTRIFUGAL DRUCKSCHMIERUNG				
AVVIAMENTO A FUNICELLA - DEMARRAGE PAR CORDELETTE ROPE STARTING - ANLASSEN: MITTELS SEILSTART				
ROTAZIONE LATO VOLANO: ORARIA - ROTATION COTE VOLANT: HORAIRE ROTATION FLYWHEEL SIDE: CLOCKWISE -DREHRICHTUNG SCHWUNGRADSEITE: UHRZEIG. SINN				

ATTENZIONE

PRIMA DI AVVIARE IL MOTORE leggere le istruzioni e osservarle scrupolosamente. L'inosservanza delle norme d'uso e manutenzione provoca la decadenza della garanzia.

ATTENTION

AVANT DE DEMARRER LE MOTEUR lire et suivre à la lettre les instructions. La garantie n'est plus valable en cas d'observation du mode d'emploi et d'entretien.

IMPORTANT

READ OPERATING AND MAINTENANCE instructions before starting your engine and stick to them. Failure to do so will make Warranty void.

ACHTUNG

VOR INBETRIEBNAHME Anleitungen lesen und sie genau befolgen. Bei Behandlungsoder Wartungsfehlern erlischt die Garantie.

* Tappo rifornimento benz.
 Bouchon remplissage essence
 Gasoline filler cap
 Kraftstoffzuführung (Benzin)

Filtro combustibile
 Filtre combustible
 Fuel Filter
 Kraftstoff-Filter

Filtro aria
 Filtre à air
 Air Cleaner
 Luftfilter

Rubinetto serbatoio
 Robinet Réservoir
 Fuel tank tap
 Kraftstoffhahn

Pulsante d'arresto
 Poussoir d'arrêt
 Switch-off button
 Abstellknopf

Tipo motore
 Type du moteur
 Engine model
 Motortyp

Tappo rifornimento petrolio
 Bouchon remplissage pétrole
 Kerosene Filler cap
 Kraftstoffzuführung (Petroleum)

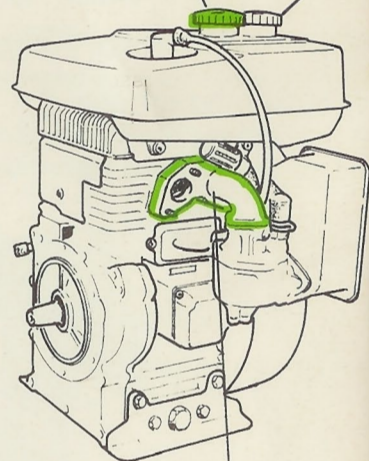
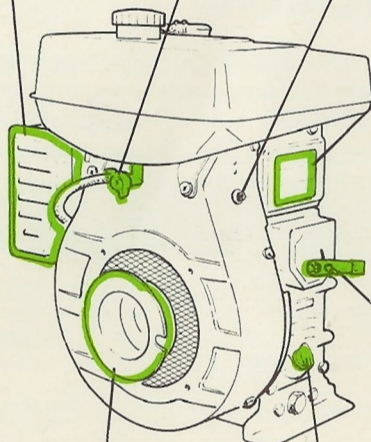
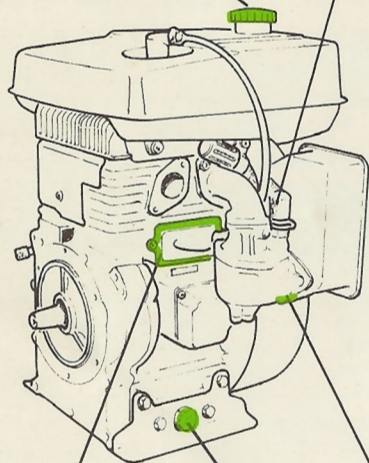

Scatola sfiato
 Couvercle reniflard
 Breather cover
 Entlüfterdeckel

Tappo scarico olio
 Bouchon vidange huile
 Oil drain plug
 Ölablass-Schraube

Farfalla starter
 Papillon starter
 Choke valve
 Starterklappe

Puleggia avviamento
 Poulie démarrage
 Starting pulley
 Anwerfscheibe

Tappo riforn. e livello olio
 Bouchon rempl. et niveau huile
 Oil filler cap and dipstick
 Öleinfüllverschluss

Acceleratore
 Accélérateur
 Throttle
 Drehzahlverstellhebel

Vaporizzatore
 Vaporisateur
 Vaporizer
 Verdampfer

IM 250 - 300 - 350

251 301 351

IM 252 - 302 - 352

Descrizioni e illustrazioni non impenative.

Descriptions et illustrations peuvent être modifiées sans avis.

Descriptions and characteristics subject to modifications without notice.

Änderungen vorbehalten

PRIMA DELL'AVVIAMENTO

AVANT LE DEMARRAGE

BEFORE STARTING

VOR DEM ANLASSEN

LUBRIFICANTE
LUBRIFIANT
LUBE OIL
SCHMIERÖL

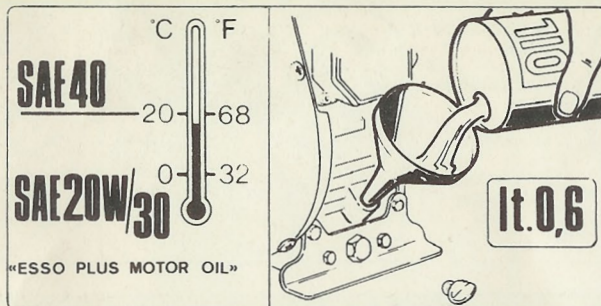

Riempiere fino a traboccamento con motore in piano.

Comando acceleratore a distanza: fissare il cavo alla levetta interna

Remplir jusqu'au bord avec le moteur en position horizontale

Fixer le câble au levier intérieur

Fill until it overflows with engine level

Connect cable to inner lever

Öl eingießen bis zum Überlaufen bei senkrecht stehendem Motor

Kabel an inneren Hebel anschließen

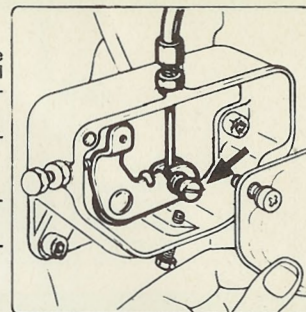

COMBUSTIBILE
COMBUSTIBLE
FUEL
KRAFTSTOFF

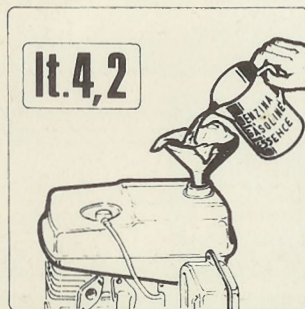

Riempiere con combustibile accuratamente filtrato

Remplir avec du combustible bien filtré

Fill tank with carefully filtered fuel

Tank mit sorgfältig gefiltertem Kraftstoff auffüllen

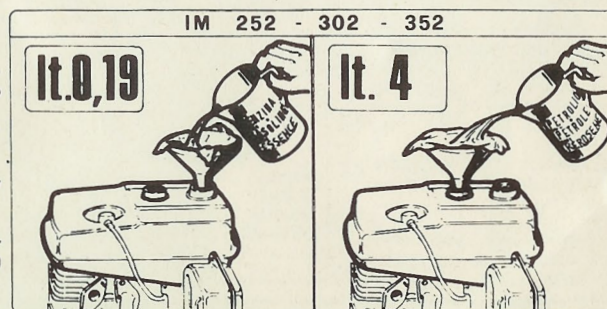

AVVIAMENTO

DEMARRAGE

STARTING

ANLASSEN

Motori 252 - 302 - 352 - Svuotare preliminarmente la vaschetta carburatore

Moteurs 252 - 302 - 352 - Vider préliminairement la cuvette carburateur

Engines 252 - 302 - 352 - Drain at first kerosene from float chamber

Motoren 252 - 302 - 352 - Vorverfahren: Schwimmergehäuse übriggebliebene Petroleum herausfließen lassen

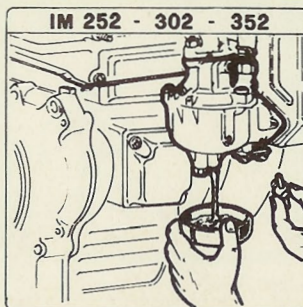

Aprire il rubinetto combustibile (benzina)

Ouvrir le robinet combustible (essence)

Open the tap (gasoline)

Hahn öffnen (Benzin)

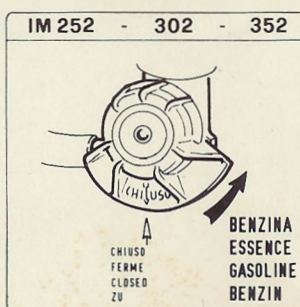

CHIUSO
FERME
CLOSED
ZU

BENZINA
ESSENCE
GASOLINE
BENZIN

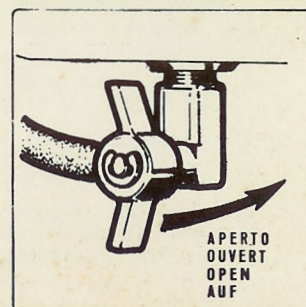

APERTO
OUVERT
OPEN
AUF

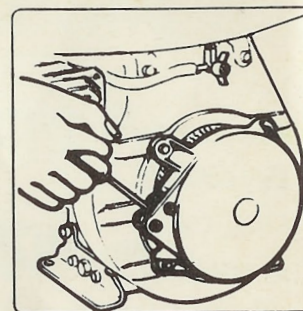
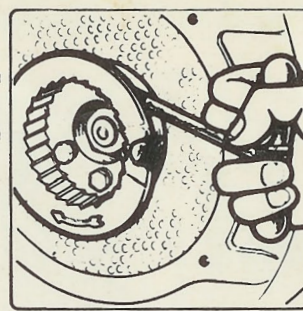
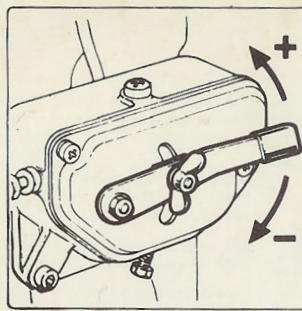
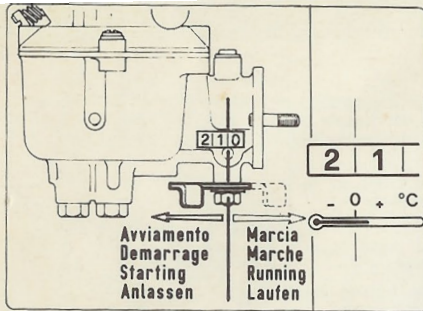

IM 252 - 302 - 352

A motore caldo passare a petrolio girando il rubinetto dal lato petrolio

A moteur chaud passer au pétrole en tournant le robinet vers le compartiment pétrole

After warm-up switch to kerosene running, turning tap toward « kerosene » side

Bei warmem Motor auf Petroleum Betrieb umstellen indem man den Hahn auf Petroleum seite stellt

IM 252 - 302 - 352

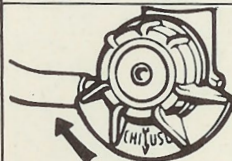

PETROLIO
PETROLE
KEROSENE
PETROLEUM

↑
CHIUSO
FERME
CLOSED
ZU

ATTENZIONE Un motore a petrolio può funzionare a benzina con le seguenti varianti:

- Candela con grado termico 95
NON E' POSSIBILE LA TRASFORMAZIONE BENZINA-PETROLIO

ATTENTION Un moteur à pétrole peut fonctionner à l'essence avec les modifications suivantes:

- Bougie avec degré thermique 95
LA TRANSFORMATION ESSENCE-PETROLE N'EST PAS POSSIBLE

IMPORTANT Kerosene engines can be converted to gasoline running with following modifications:

- 95 Heat Range spark plug
CONVERSION FROM GASOLINE TO KEROSENE IS NOT FEASIBLE

ACHTUNG Petroleum motoren Können durch folgenden Aenderungen auf benzin umgestellt werden:

- Zündkerze mit 95 Wärmewert
DIE UMSTELLUNG BENZIN-PETROLEUM IST NICHT MÖGLICH

ARRESTO

ARRET

STOPPING

ABSTELLEN

- Riscaldare il motore prima di applicare il carico
Accelerare gradualmente
Non funzionare a lungo al minimo.
- Chauffer le moteur avant de le charger
Augmenter graduellement la vitesse
Ne pas tourner longtemps au ralenti.
- Warm-up engine before loading
Bring it gradually to operating speed
Do not idle for long periods.
- Motor vor der Belastung warmlaufen
Allmählich Vollastdrehzahl erreichen
Nicht lange im Leerlauf laufen.

Girare al minimo alcuni minuti prima dell'arresto.

Tourner au ralenti quelques minutes avant l'arrêt.

Idle a few minutes before stop.

Vor dem Abstellen Motor einige Minuten im Leerlauf lassen.

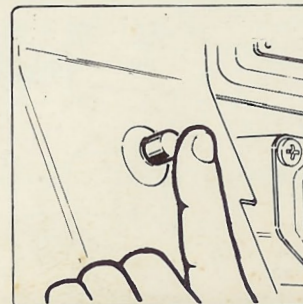

IM 252 - 302 - 352

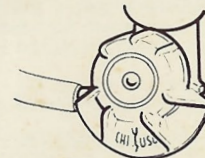

↑
CHIUSO
FERME
CLOSED
ZU

8



25
(8▲)

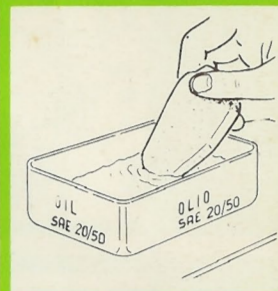
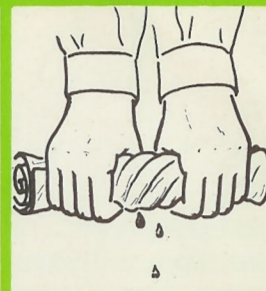

ATTENZIONE : Ogni 8 ore, verificare e rabboccare livello olio
ATTENTION : Verifier et retenir niveau huile toutes les 8 heures
IMPORTANT : Every 8 hours check oil level and refill
ACHTUNG : Alle 8 Stunden Ölstande prüfen und wiederherstellen

Pulire le masse con benzina, se necessario succesivam. con acqua e sapone
 Nettoyer les masses avec essence, en suite avec eau savonneuse
 Clean elements with gasoline, if necessary wash with water and soap
 Luftfilterelement mit benzin und eventuell mit Seifenwasser Sanbermachen

Avvolgere in uno straccio e strizzare
 Envelopper dans un chiffon et presser
 Wrap in a rag and squeeze firmly till dry
 Mit einem Lappen wickeln und wringen

Immergere in olio, quindi strizzare
 Plonger dans de l'huile, donc presser
 Dip in oil and squeeze to remove excess of oil
 Ins Öl eintauchen und leicht wringen

50

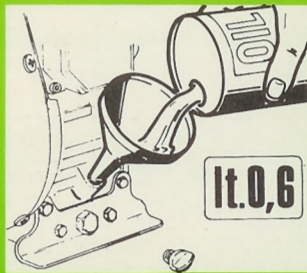
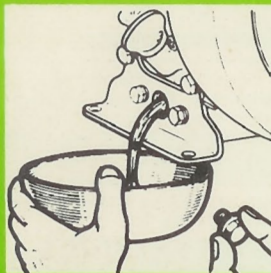

Filtro combustibile
 Filtre combustible
 Fuel Filter
 Kraftstoff-filter

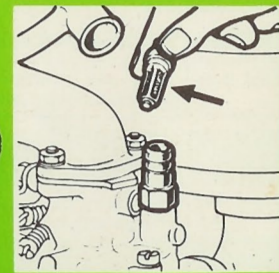

300

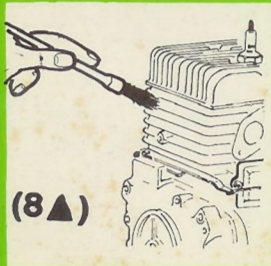

(8▲)



0,8 mm



0,15 mm

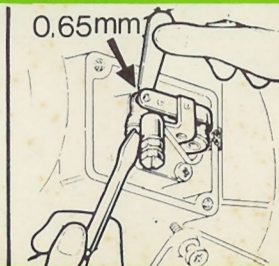

0.65 mm



Smontare la candela e pulirla con spazzola metallica e benzina.

Démonter la bougie, la nettoyer avec une brosse métallique et rincer à l'essence.

Remove spark plug, clean by wire brushing and wash with gasoline.

Zündkerze abschrauben und sie mit Metallbürste und Benzin reinigen.

500



(8▲)

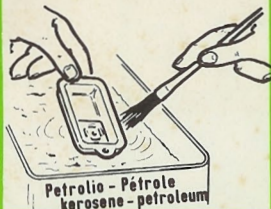

SOSTITUZIONE CANDELA
REPLACEMENT BOUGIE
SPARK PLUG REPLACEMENT
ZÜNDKERZE WECHSEL

CANDELA
BOUGIE
SPARK PLUG
ZÜNDKERZE

IM 250 - 251 - 300 - 350 - 301 - 351
BOSCH W 10 A - MARELLI CW 4N - CHAMPION L90 - KLG F50

IM 252 - 302 - 352
BOSCH W 12 A - MARELLI CW 2N

1000

REVISIONE
REVISION
OVERHAUL
OBERHOLUNG



Parziale - Partielle - Top - Teilweise

2000

Generale - Générale - Total - Völlige

(8▲) In ambienti molto polverosi o in condizioni particolari

Dans une atmosphère poussiéreuse et en conditions particulières

Under dusty or heavy conditions

In Staubiger Umgebung oder unter besonderen Bedingungen

RODAGGIO

RODAGE

RUN-IN

EINLAUFEN

Prime 50 ore non superare il 70% del carico normale

Premières 50 H. ne pas dépasser 70% charge normal

First 50 Hours: operate below 70% normal load

Erste 50 stundem nicht über 70% der Volkstdelasten

IMMAGAZZINAGGIO

STOCKAGE

STORAGE

KONSERVIERUNG

Da 1÷6 mesi. Oltre rivolgersi alle Stazioni di Servizio

1÷6 Mois. Au dela s'adresser aux Agents de Service

1 to 6 Months. Over contact Service Centers

1 bis 6 Monate. Wenn länger Vertragswerkstätten Konsultieren

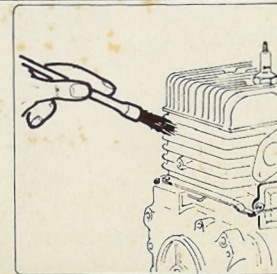
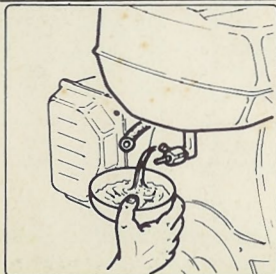

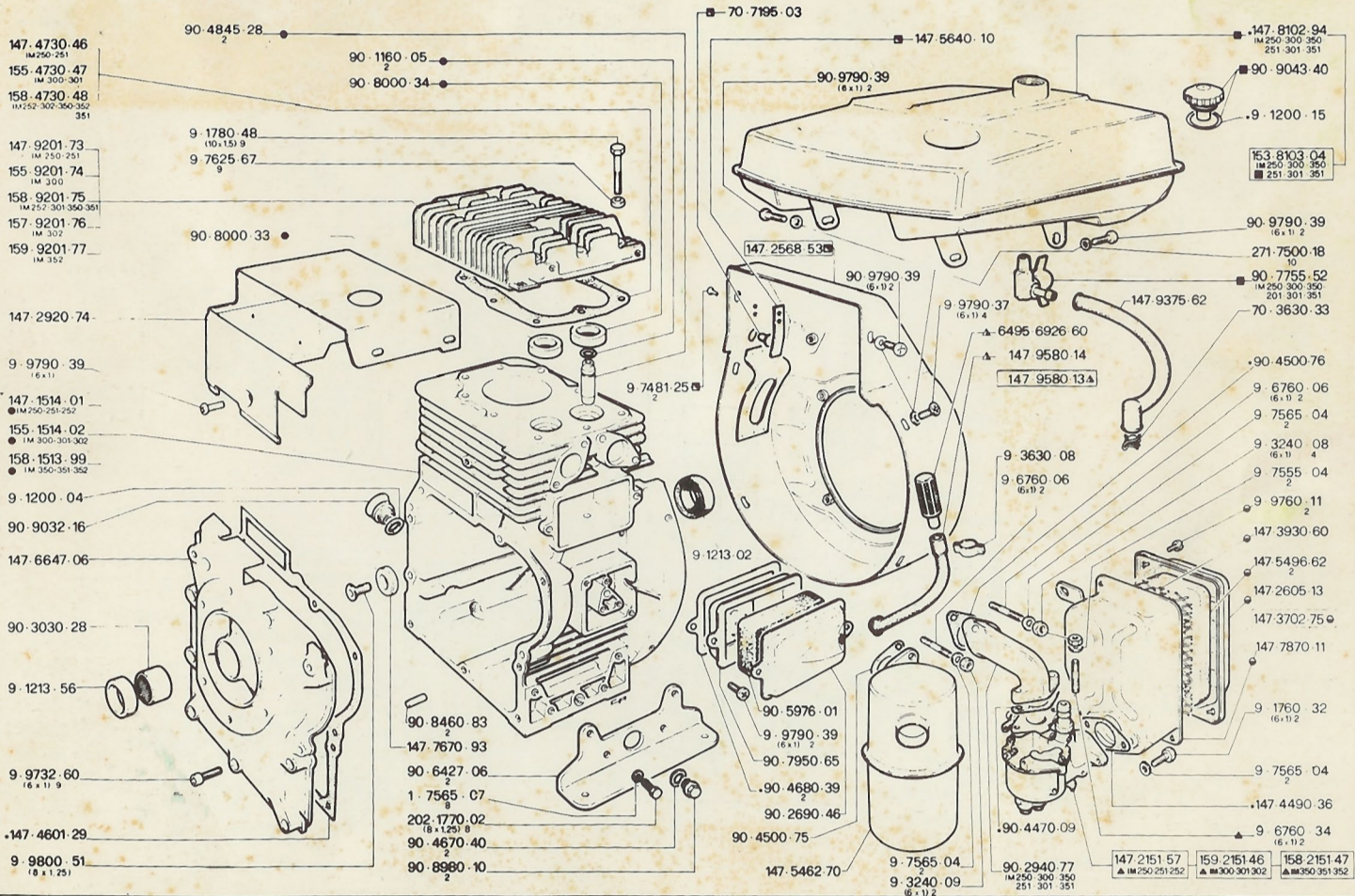

Non fornito sciolto

Non livré séparément

Not supplied separately

Einzel nicht lieferbar

RICAMBI - PIECES DETACHEES - SPARE PARTS - ERSATZTEILE

t. 2

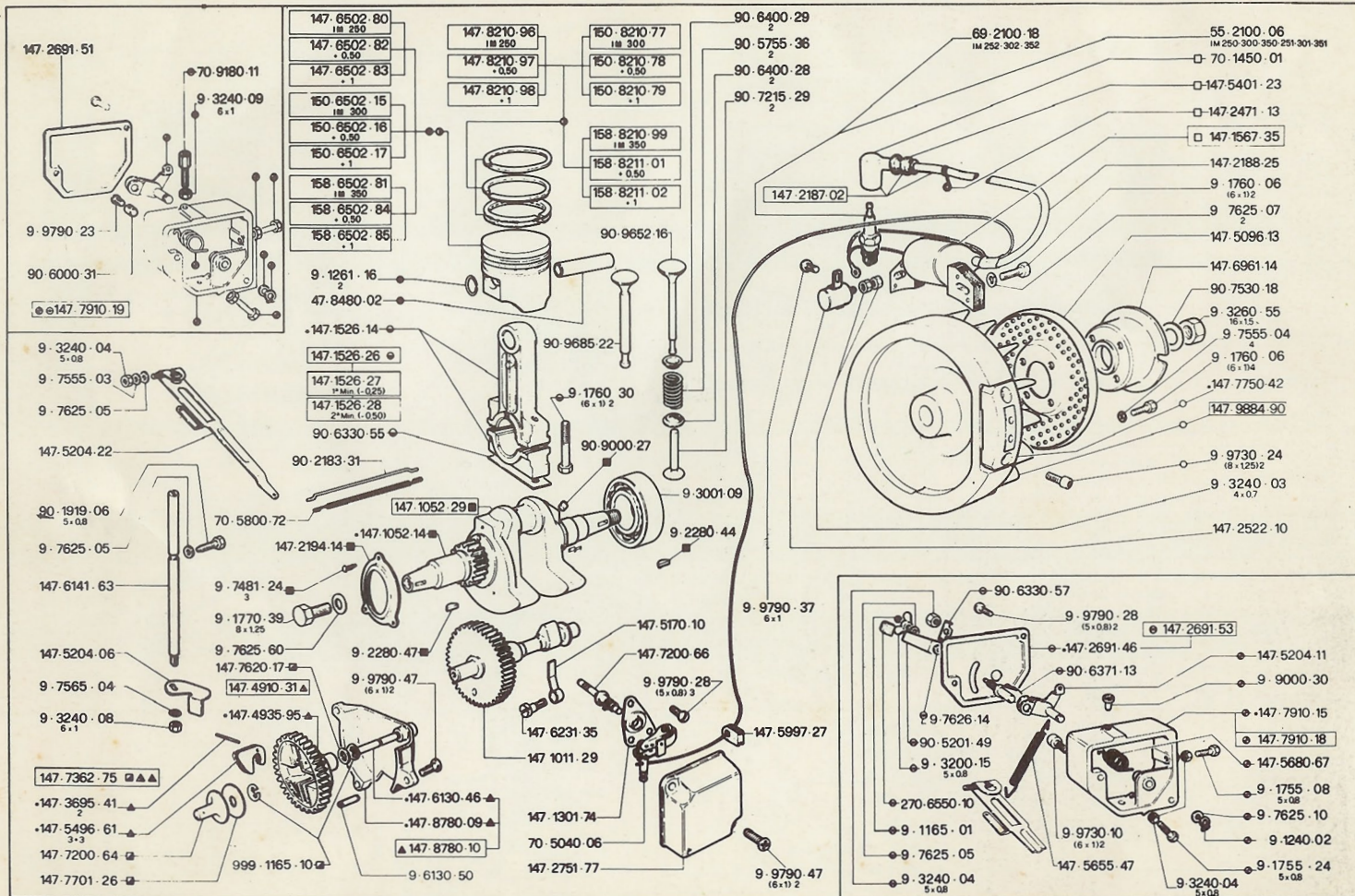

147 - 8180 - 57 (IM 250-251)
 155 - 8180 - 58 (IM 300-301)
 158 - 8180 - 59 (IM 252-302-350-352-351)

Serie guarnizioni

Jeu de joints

Gasket set

Dichtungssatz

RICAMBI - PIECES DETACHEES - SPARE PARTS - ERSATZTEILE

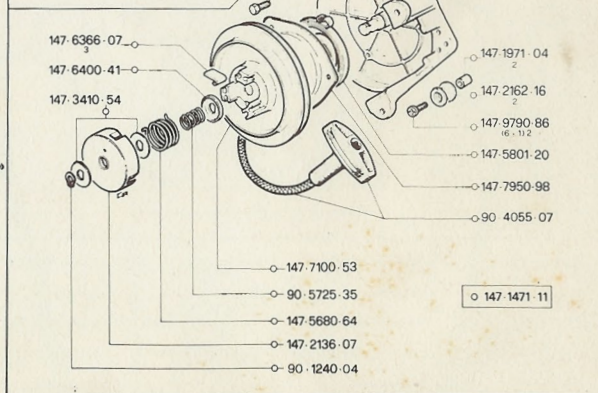
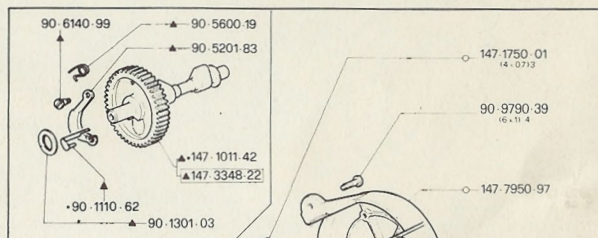
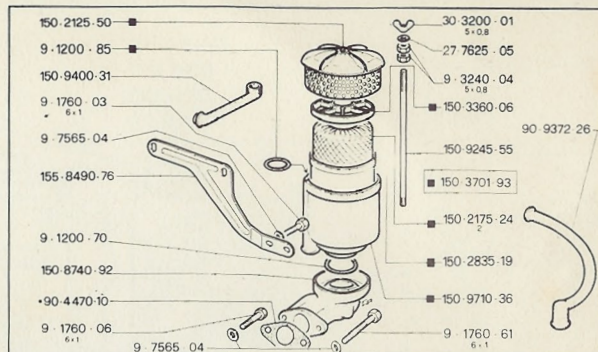
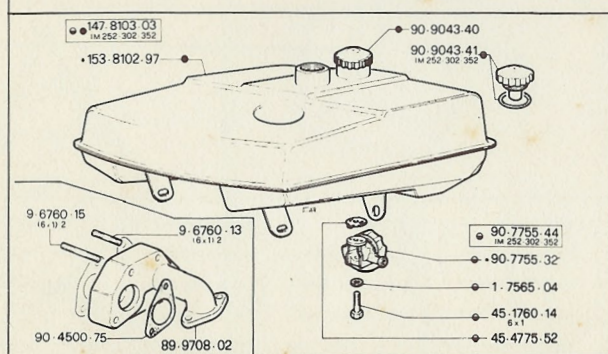
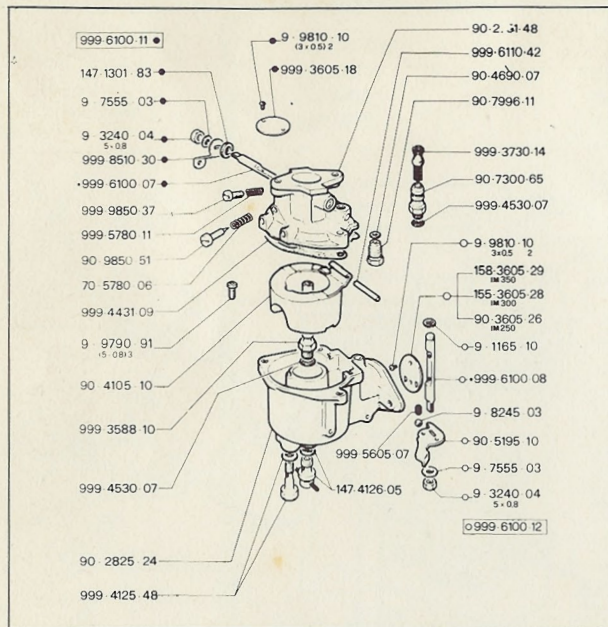

**filtro aria
a bagno di
olio «fornibile
a Richiesta»**

**filtre à air
à bain d'huile
«Sur Demande»**

**Oil bath air
cleaner,
«Optional»**

**Ölbadluftfilter
«Zusatzausrüstung»**

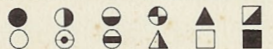

Particolari appartenenti ad un gruppo completo

Pièces composant un groupe complet

Parts included in a complete group

Teile einer kompl. Gruppe

SCHEMI ELETTRICI - SCHEMAS ELECTRIQUES - WIRING DIAGRAMS - SCHALTSCHEMAS

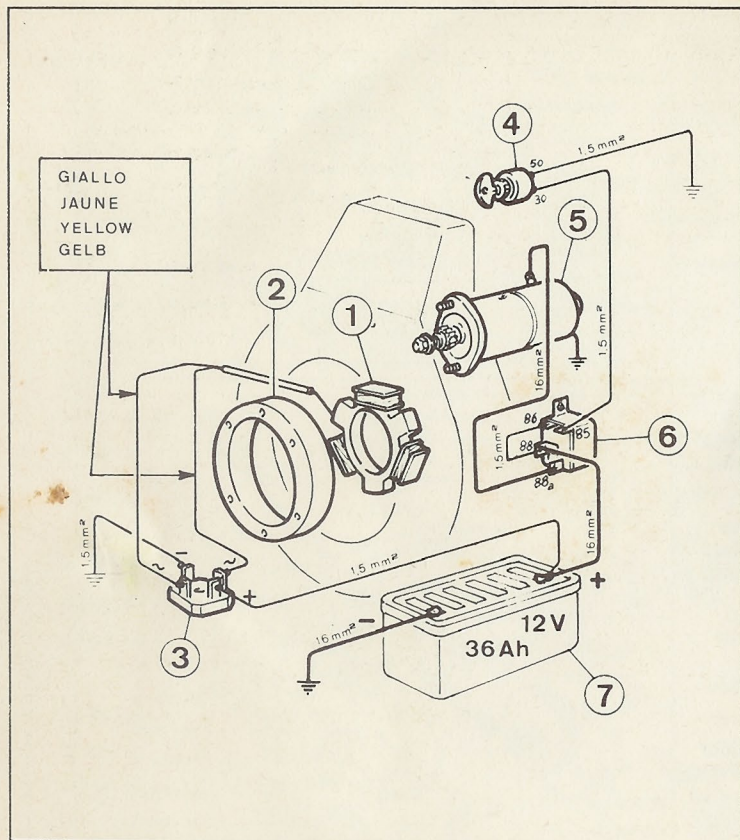

1	Indotto altern.	Induit alternatif	Alter. armat. winding	Anker des drehstr. gen.
2	Induttore	Inducteur	Inductor	Erreger
3	Ponte raddr.	Pont de redressement.	Rectifying bridge	Gleichrichterbrücke
4	Interruttore avv.	Interrupt. démarrage	Starting Keyswitch	Anlass-schalter
5	Motorino	Démarrreur	Starting motor	Anlassmotor
6	Interrutt. a solen.	Interrupt. à solénoïde	Solenoid switch	Magnetschalter
7	Batteria	Batterie	Battery	Batterie

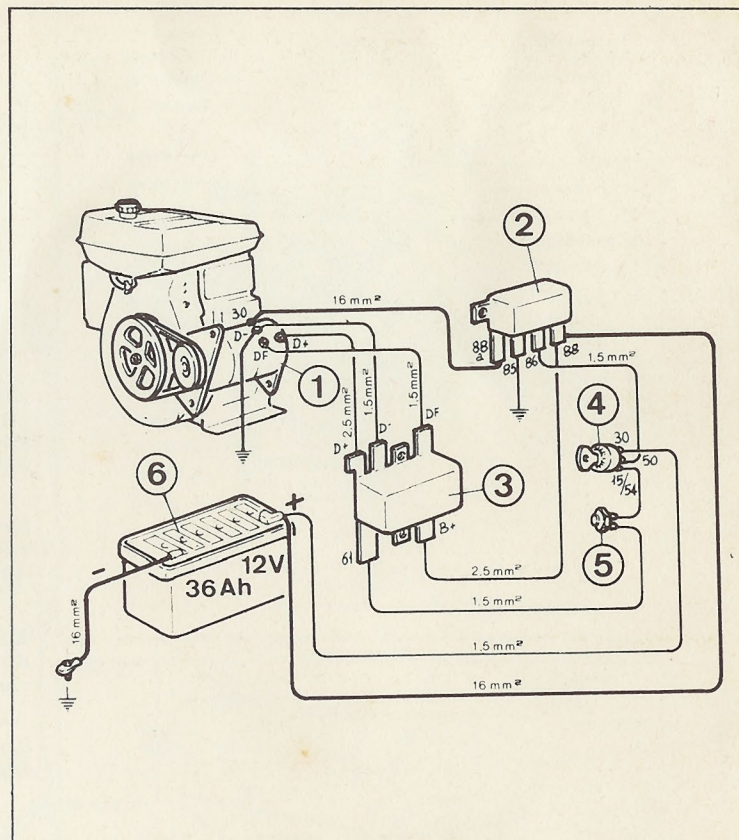

1	Dinamotore	Dynastart	Starter generat.	Lichtenlasser
2	Interrutt. a solen.	Interrupt à solénoïde	Solenoid switch	Magnetschalter
3	Regolat. tensione	Régulateur de tens.	Voltage regulator	Spannungsregler
4	Interrutt. avviam.	Interrupt démarr.	Starting Keyswitch	Anlass-schalter
5	Spia carica batteria	Témoin charge batt.	Battery charg. warn. light	Batterie-ladeanzeiger
6	Batteria	Batterie	Battery	Batterie

NORME DI SICUREZZA
NORMES DE SECURITE
SAFETY RULES
SICHERHEITSMASS-
NAHMEN



CORRETTO
CORRECT
CORRECT
RICHTIG

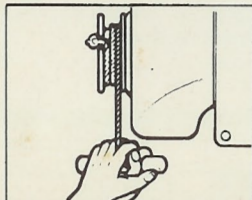
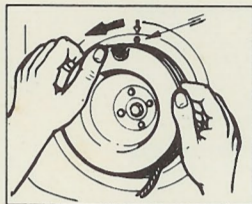
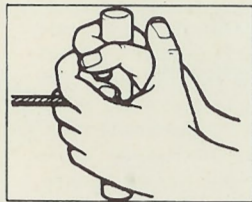
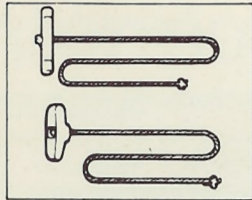

ERRATO
ERRONE
WRONG
FALSCH

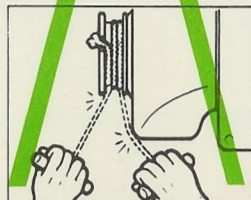
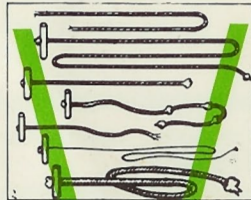

CORRETTO
CORRECT
CORRECT
RICHTIG

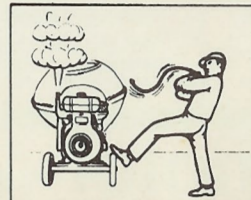
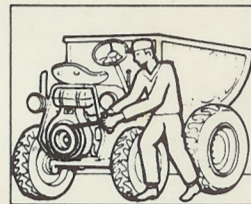
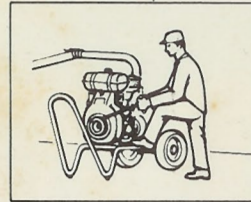
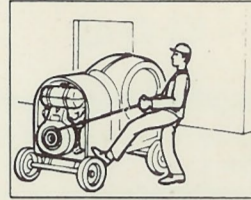

ERRATO
ERRONE
WRONG
FALSCH

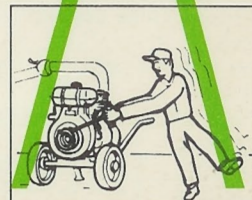
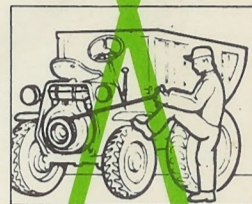
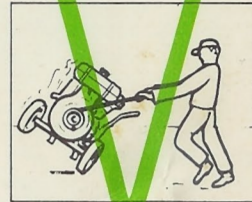
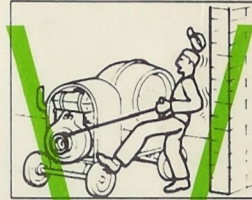



ASSISTENZA - RICAMBI

Per assistenza, riparazioni e ricambi, rivolgersi alle Stazioni di Servizio con la targa SERVICE come da elenco della busta accessori o delle PAGINE GIALLE dello Elenco Telefonico alla voce « Motori ». Esse sono autorizzate a intervenire, in garanzia e fuori, su tutti i motori INTERMOTOR, con personale addestrato, attrezzature speciali e ricambi originali.

ORDINI RICAMBI indicare:

Tipo del motore (targhetta)
Matricola (sulla targhetta o basamento)
Tipo e marca della macchina
Matricola del ricambio.

SERVICE - PIECES

Pour le service après vente, la réparation ou les pièces détachées, adressez-vous aux Agents avec l'enseigne SERVICE indiqués dans la liste de la pochette accessoires, et qui sont autorisés à intervenir sur tout moteur INTERMOTOR, en garantie et hors garantie, avec personnel entraîné, des équipements spéciaux et des pièces détachées originales.

COMMANDES PIECES DETACHEES indiquer:

Type du moteur (plaquette)
Matricule (plaquette ou carter)
Type et marque de la machine
Référence de la pièce.

SERVICE - PARTS

For service, repairs and spare parts contact Service Centers displaying the SERVICE sign. (See list inside your accessories envelope). They are authorized to repair all INTERMOTOR engines within and beyond the warranty period, with trained mechanics, genuine parts and special tools.

PART ORDERS, specify:

Engine type (on plate)
Serial No. (plate or crankcase)
Equipment type and Make
Spare Part No.

SERVICE - ERSATZTEIL.

Für Service, Reparaturen oder Ersatzteile wenden Sie sich an die Vertragswerkstätten mit dem Schild SERVICE (Siehe Verzeichnis der Zubehörtasche). Sie arbeiten mit Personal, das im Werk ausgebildet wurde, mit Spezialwerkzeug und Original-Ersatzteilen.

E-TEIL BESTELLUNGEN. Folgendes angeben:

Motortyp (auf dem Schild)
Nummer (auf Schild oder Kurbelgehäuse)
Maschinentyp und-marke Bestellnummer des Teiles.



intermotor s. p. a.



LOMBARDINI Company

02100 RIETI - ITALY - Casella Postale 107 - tel. (0746) 72041 - INTERMOTOR - TELEX: 612595 IMOTOR

147 - 5302 - 02

Mod. 301 - 44.000/6-79