

BDU-10/21

Hydrostatic Transmissions

Service and Repair Manual

BLN-50327
January 2009

Table of Contents

Description	Page
Introduction	3
General Description	3-5
Fluids.....	6
Safety Precautions	6
Maintenance	6
Troubleshooting Diagram	7
Troubleshooting Chart.....	8
Minor Repairs	9-14
General Information	9
Shaft Seals	9-10
Charge Check Valves	10-11
Bypass Valves	11
Easy Ride Valves	11
Charge Pumps	12-14
Major Repairs	14-21
General Information	14
Disassembly Procedures	15-17
Reconditioning & Replacement of Components	17
Assembly Procedures	17-21
BDU-10S Parts Drawing & Parts List.....	22-23
BDU-10L Parts Drawing & Parts List.....	24-25
BDU-21L Parts Drawing & Parts List.....	26-27

Introduction

The purpose of this manual is to provide information useful in servicing the BDU Hydrostatic Transmission product line. This manual includes unit and component description, troubleshooting, maintenance, and repair procedures.

A transmission normally will not require servicing, other than the vehicle manufacturer's recommended fluid and filter changes during the life of the vehicle in which it is installed. Should other servicing be required, the unit must be removed from its installed location and thoroughly cleaned before beginning most procedures.

General Description

The BDU Hydrostatic Transmission is designed for the transfer and control of power. It provides an infinitely variable speed range between zero and maximum in both forward and reverse modes of operation. The BDU transmission can be mounted to a variety of transaxles including most HYDRO-GEAR models.

The BDU transmission is a "U" style transmission with a variable displacement pump and a fixed displacement motor. The variable displacement pump features a cradle swashplate with a direct-proportional displacement control. Reversing the direction of tilt of the swashplate reverses the flow of oil from the pump and thus reverses the direction of the motor output rotation. The fixed displacement motor uses a fixed swashplate. The pump and motor are of the axial-piston design and utilize spherical-nosed pistons which are held against a thrust race by internal compression springs.

The fluid supply for the BDU-10L/21L transmission is contained in an external reservoir and passes through an external filter prior to entering the transmission and feeding the fixed displacement gerotor charge pump. Excess fluid in the charge circuit is discharged over the charge relief valve back to the charge pump inlet. Constant flow across a small fixed orifice connecting the charge circuit to the transmission housing supplements the cooling flow.

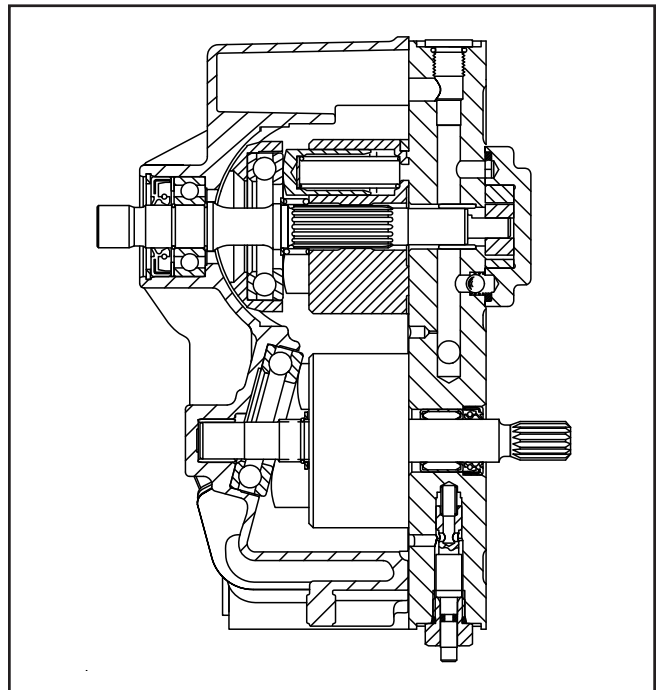

BDU-10L Transmission

The BDU-10S transmission has a self-contained fluid supply and an integral filter. The fluid is forced through the filter by positive "head" on the fluid in the housing/reservoir with an assist by the negative pressure created in the pump pistons as they operate.

Charge check valves in the center section are used to control the makeup flow of fluid to the low pressure side of the loop.

A spool type bypass valve is utilized in the transmission to permit moving the vehicle for short distances at low speeds (2mph) (3.2 km/hr) without starting the engine.

The BDU-21L transmission offers an optional Implement (auxiliary) pump. The auxiliary circuit provides a rated flow of 1.5 gpm (5.67 l/min) and 500 PSI (34.5 bar) operating pressure at a 3200 RPM pump speed.

Fluid from the charge pump flows first to the implement control valve, then to the charge relief valve and charge check valves in the center section. This requires an "open center" type control valve to allow fluid flow to return to the transmission. A check valve is included to allow oil to be drawn into the charge circuit should flow returning from the implement circuit be insufficient to charge the closed loop. A relief valve must be included in addition to the implement control valve.

The BDU-21L offers an Easy Ride Valve option. The Easy Ride Valve acts like a high pressure spike suppressor in the system loop. The valve opens under high acceleration loads. The result is a dampening of the aggressiveness, without affecting the overall efficiency of the transmission.

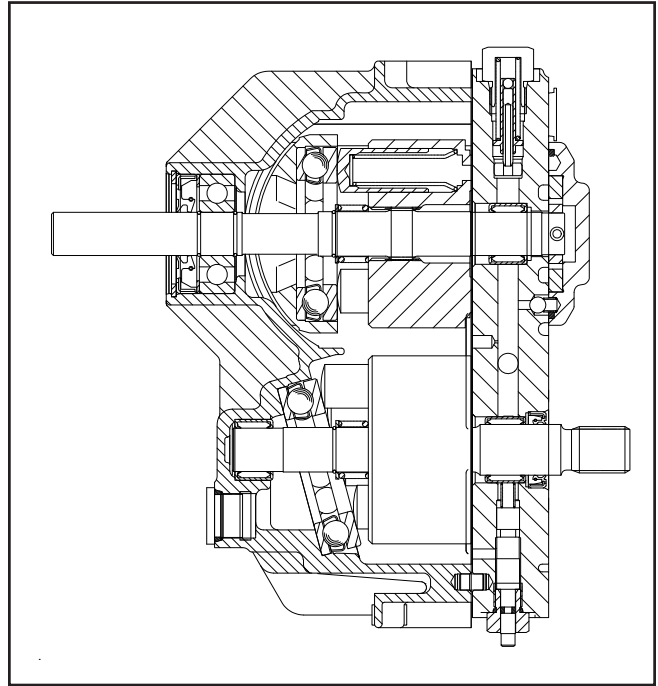

BDU-21L Transmission with Easy Ride Valve Option

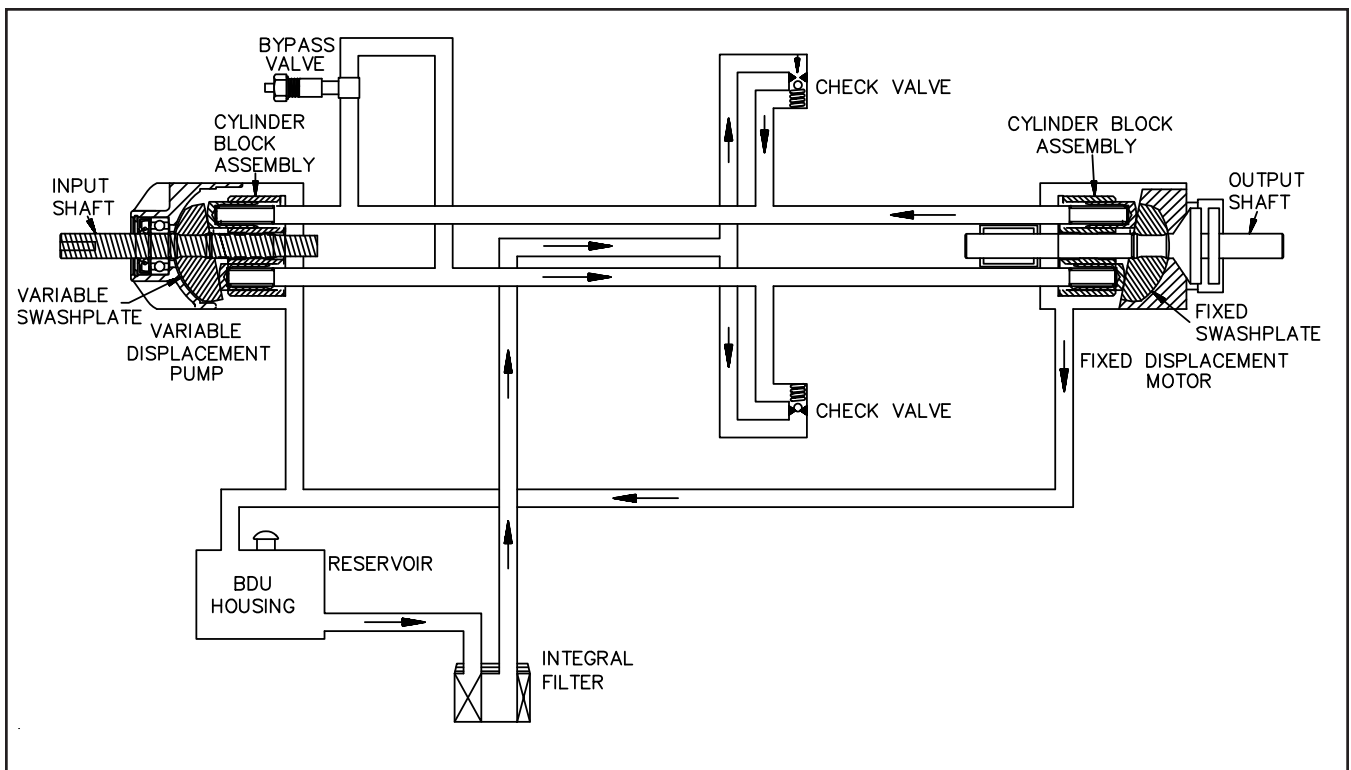

BDU-10S Hydrostatic Flow Illustration

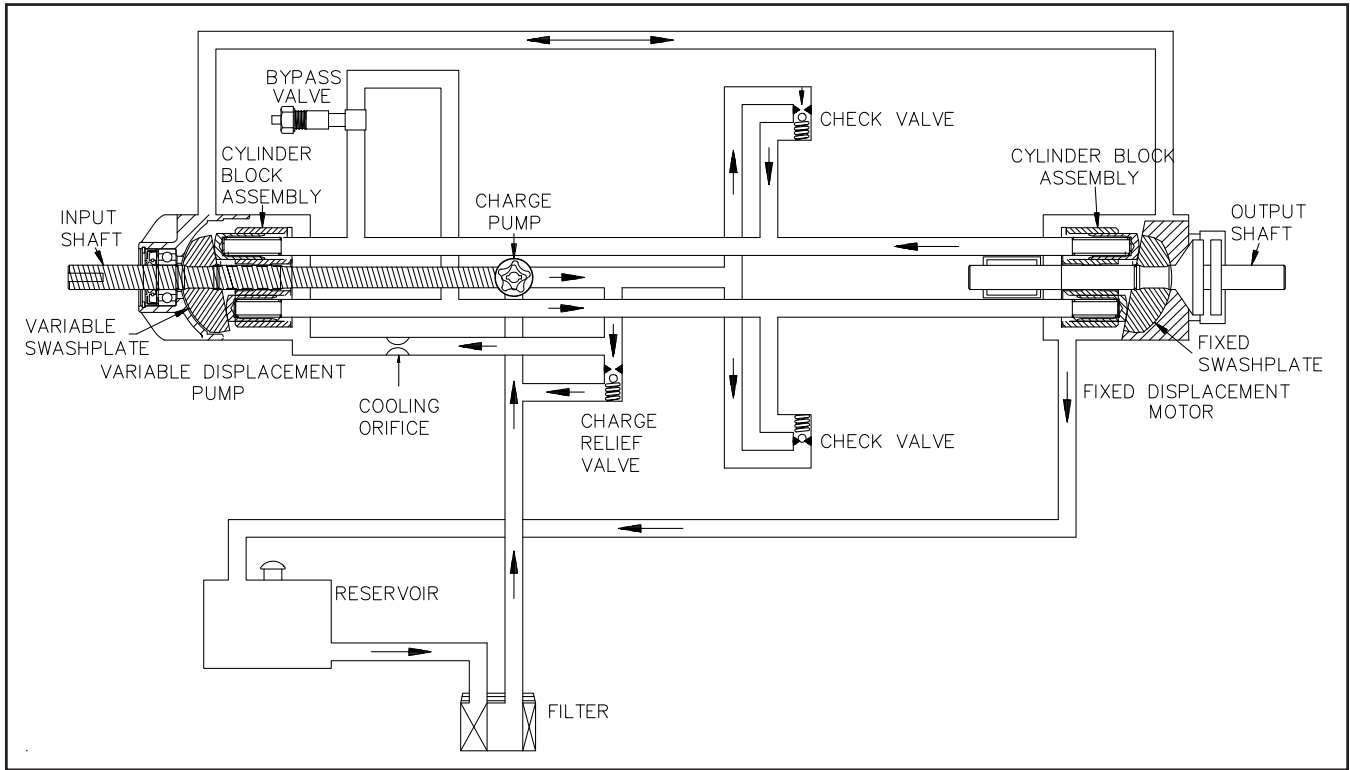

BDU-10L/21L Hydrostatic Flow Illustration

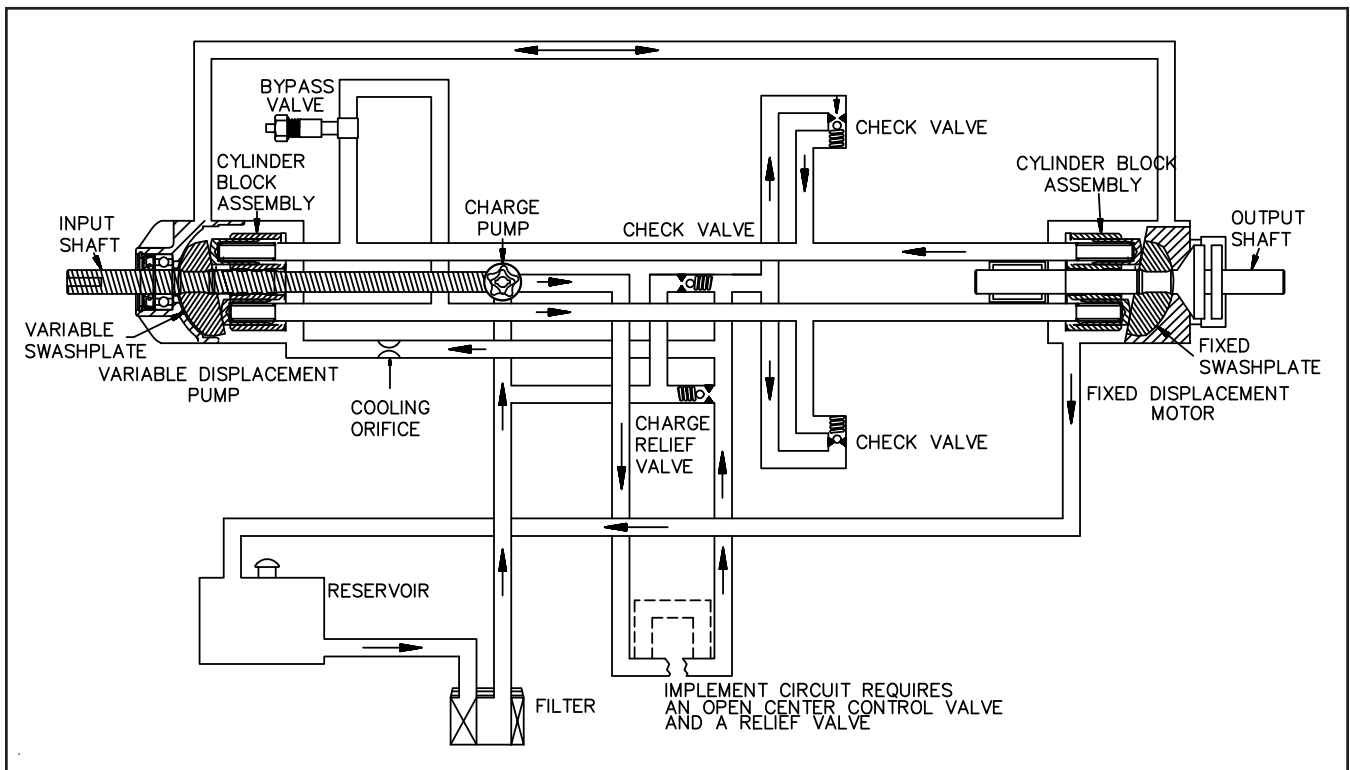

BDU-21L/A Hydrostatic Flow Illustration

Fluids

The fluids used in HYDRO-GEAR products have been carefully selected, and only equivalent, or better products should be substituted.

Typically, an engine oil with a minimum rating of 9.0 cSt (55 SUS) at 230°F (110°C) and an API classification of SJ/CD is recommended. A 20W-50 engine oil has been selected for use by the factory and is recommended for normal operating temperatures. For colder climate operation (see chart), a change to a 10w-40 engine oil may be necessary. Another alternative that will provide excellent all climate performance and extended time between oil changes is a 15W-50 synthetic engine oil.

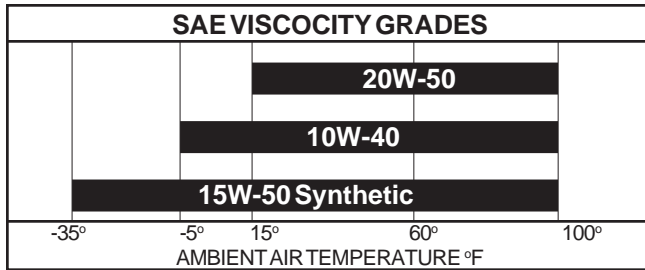

Safety Precautions

Certain procedures may require the vehicle to be disabled (wheels raised off the ground, engine disconnected, etc.) in order to prevent possible injury to the technician and bystanders.

Some cleaning solvents are flammable. To avoid possible fire, do not use cleaning solvents in an area where a source of ignition may be present.

The loss of hydrostatic driveline power may result in the loss of hydrostatic braking capacity. Proper brake maintenance becomes very important should this condition develop.

Maintenance

Check the transmission cooling fan for broken or distorted blades, and check to see that the fan is securely fastened. Replace the fan if damaged.

Keep the transmission clean. Grass clippings and dirt will influence the cooling efficiency of the fins on the transmission housings. Avoid high pressure fluid washes, compressed air is the preferred method of removing loose debris. Avoid the immediate area of the lip seals or damage may occur.

Check to make sure the bypass valve and linkage is operational. The bypass valve should be fully released before operating the vehicle. It should extend approximately 0.22" (5.588mm) from the hex nut.

Inspect the transmission for leaks at the lip seals, damage to fittings, hoses, the filter, or to the housings. Check the oil level and add oil as necessary to bring it up to the proper level. Refer to vehicle owners manual.



BDU-10L



BDU-21L/A

OPERATES IN ONE DIRECTION ONLY

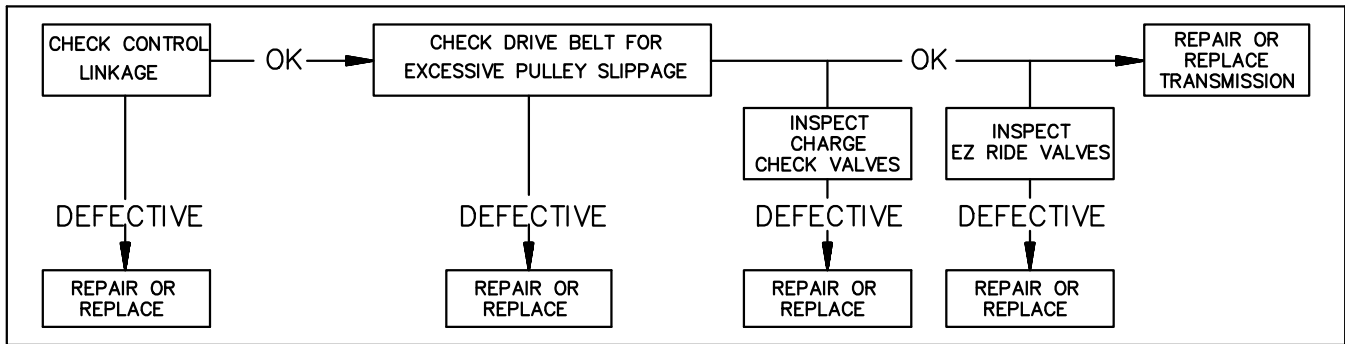

OPERATING HOT/LOSING POWER

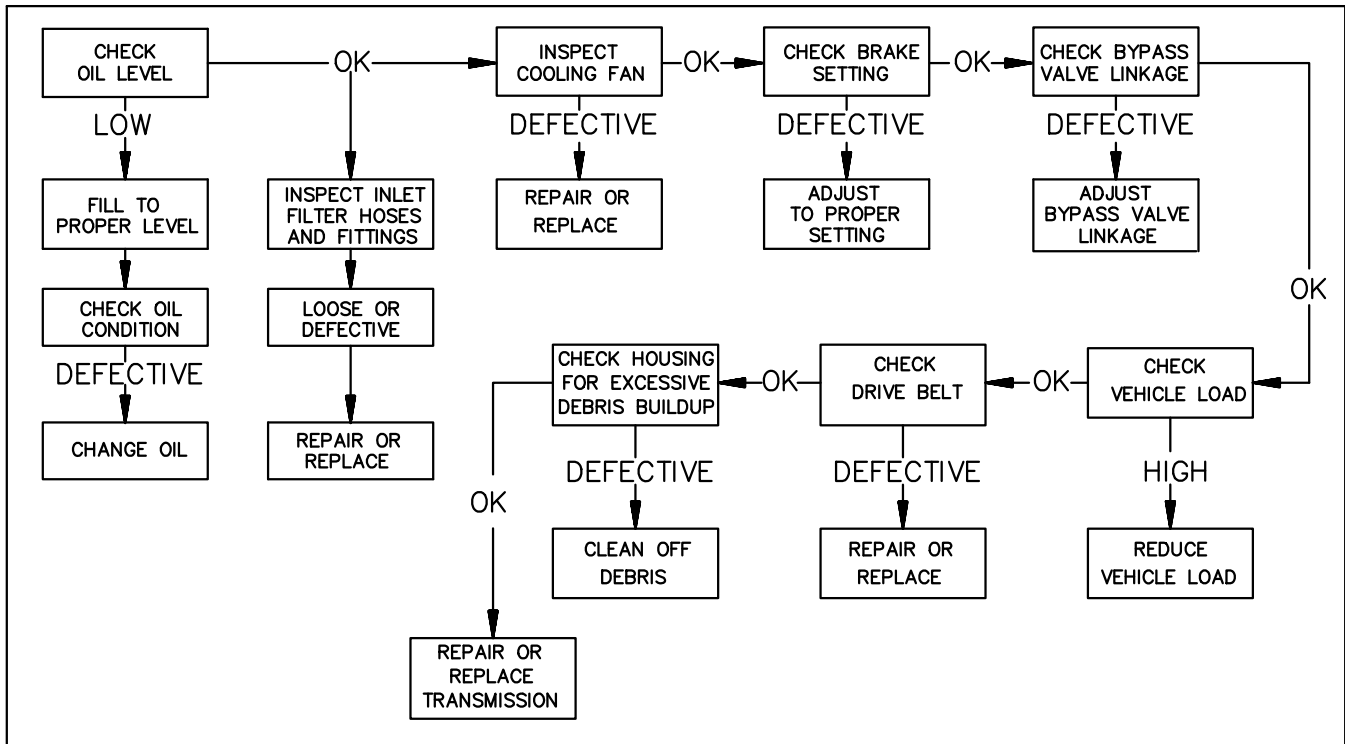

NOISY UNDER LOAD

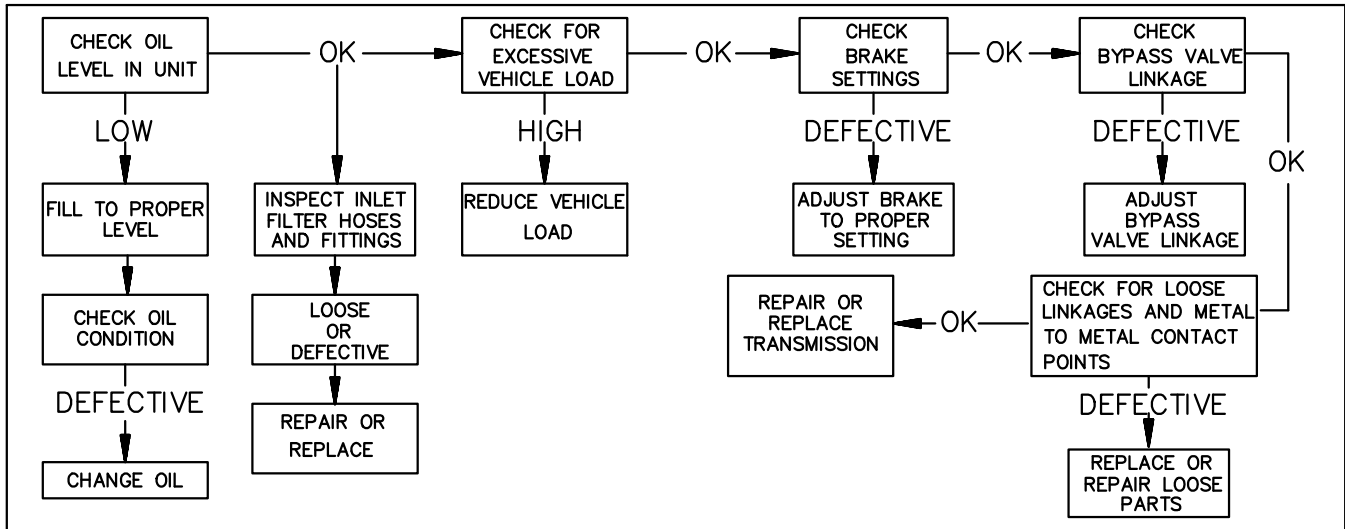

WARNING!!!

**THE VEHICLE SHOULD BE ON LEVEL GROUND AND
THE ENGINE DISABLED BEFORE PERFORMING ANY ADJUSTMENTS**

SYMPTOM - OPERATES IN ONE DIRECTION ONLY

POSSIBLE CAUSE

- Inspect control linkage
- Inspect drive belt & pulleys
- Inspect check valves
- Inspect easy ride valves

CORRECTIVE ACTION

- Repair or replace
- Repair or replace
- Repair or replace
- Repair or replace

SYMPTOM - NOISY

POSSIBLE CAUSE

- Check oil level & condition
- Check for excessive loading
- Check brake setting
- Check for loose parts
- Check bypass valve operation
- Check inlet flow conditions
- Inspect check valves
- Inspect easy ride valves
- Inspect auxillary circuit

CORRECTIVE ACTION

- Fill to proper level or change oil
- Reduce vehicle loading
- Adjust brake to proper setting
- Repair or replace loose parts
- Repair or replace valve or linkage
- Repair or remove obstruction or leaks
- Repair or replace
- Repair or replace
- Repair or replace

SYMPTOM - LOW POWER

POSSIBLE CAUSE

- Check engine RPM
- Check drive belt & pulleys
- Check oil level & condition
- Check for excessive loading
- Check brake setting
- Check for loose parts
- Check bypass valve operation
- Check inlet flow conditions
- Check operating temperature
- Inspect check valves
- Inspect easy ride valves
- Inspect auxillary circuit

CORRECTIVE ACTION

- Adjust to correct setting
- Repair or replace
- Fill to proper level or change oil
- Reduce vehicle loading
- Adjust brake to proper setting
- Repair or replace loose parts
- Repair or replace valve or linkage
- Repair or remove obstruction or leaks
- Repair or replace unit
- Repair or replace
- Repair or replace
- Repair or replace

SYMPTOM - OPERATING HOT

POSSIBLE CAUSE

- Check bypass valve operation
- Check for debris buildup
- Check oil level & condition
- Check for excessive loading
- Check brake setting
- Check cooling fan for damage
- Inspect check valves
- Inspect easy ride valves
- Inspect auxillary circuit

CORRECTIVE ACTION

- Repair or replace
- Clean off debris
- Fill to proper level or change oil
- Reduce vehicle loading
- Adjust brake to proper setting
- Repair or replace
- Repair or replace
- Repair or replace
- Repair or replace

Minor Repair

General Information

Minor repairs may be performed, following the procedures in this section, without voiding the unit warranty.

Cleanliness is a primary means of assuring satisfactory life on either new or repaired units. Cleaning parts by using solvent wash and air drying is usually adequate. As with any precision equipment, all parts must be kept free of foreign materials and chemicals.

Protect all exposed sealing surfaces and open cavities from damage and foreign material. The outer surfaces must be cleaned before beginning any repairs.

It is recommended that all O-rings and seals be replaced. Lightly lubricate all O-rings and seals with a clean petroleum jelly prior to assembly.

Plug/Fitting Torques

If any plugs were removed during servicing, they should be torqued as indicated in the accompanying table:

TORQUE SPECIFICATIONS		
OPERATION	TORQUE	PART DESCRIPTION
Bypass Plug	84-120 lb in (9.5-13.5 Nm)	7/16-20 SAE Straight Thread
Check Plug(s)	180-240 lb in (20-27 Nm)	9/16-18 SAE Straight Thread
Easyride Plug	180-240 lb in (20-27 Nm)	9/16 SAE Straight Thread
Steel Plug/Fitting	96-120 lb in (10.8-13.5 Nm)	7/16 SAE Straight Thread
Steel Plug/Fitting	180-240 lb in (20-27 Nm)	9/16 SAE Straight Thread
Steel Plug/Fitting	180-240 lb in (20-27 Nm)	3/4 SAE Straight Thread
Steel Plug/Fitting	180-240 lb in (20-27 Nm)	7/8 SAE Straight Thread

Shaft Seals

Lip type seals are used on the pump input shaft, pump through shaft (not all models use the through shaft), motor output shaft and displacement control shaft. These seals can be replaced without major disassembly of the unit. However, replacement of the seals generally requires removal of the transmission from the machine.

To replace the pump input shaft seal, first remove the retaining ring from the housing.

Carefully pull the seal out of the housing bore. A "hook" type tool may be used to grasp the seal and pull it out, or a slide hammer type puller may be used to remove the seal. Care must be taken so as not to damage the housing bore, shaft sealing surface, or bearing. Once removed, the seal is not reusable.

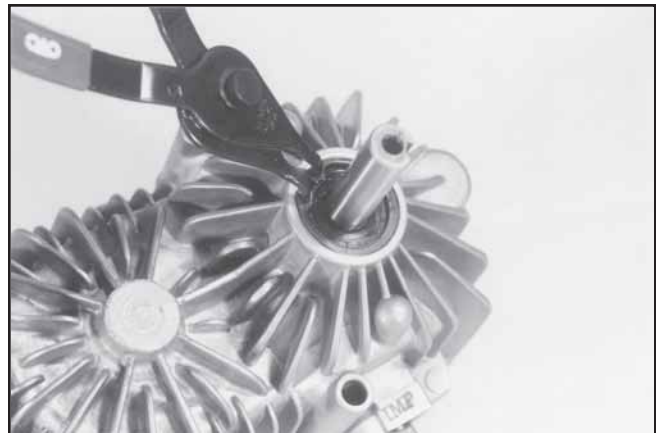

Retaining Ring Removal



Lip Seal Removal

Shaft Seals

Inspect the sealing area on the shaft for rust, wear, or contamination. Polish the sealing area on the shaft if necessary.

Wrap the spline or keyed end of the shaft with with a thin plastic or cellophane to prevent damage to the seal lip during installation.

Lubricate the new seal with petroleum jelly and slide the seal over the shaft and press it into the housing bore. Be careful not to damage the seal.

Install the retaining ring in the housing.

The pump through shaft, motor output shaft and displacement control shaft may be replaced following a similar procedure as outlined for the pump input shaft seal. These seals are not held in position by a retaining ring.



Lip Seal Installation

Charge Check Valves

Remove the check valve plug with a 1/4" internal hex wrench.

Remove the check valve spring and check ball (or poppet) from the center section.

CAUTION: Do not allow the check ball to fall into the closed loop passages in the center section. Removal may be difficult but can be accomplished with a magnet, or by removing the plug from the end of the center section. Do not allow contaminants to be introduced to the system.

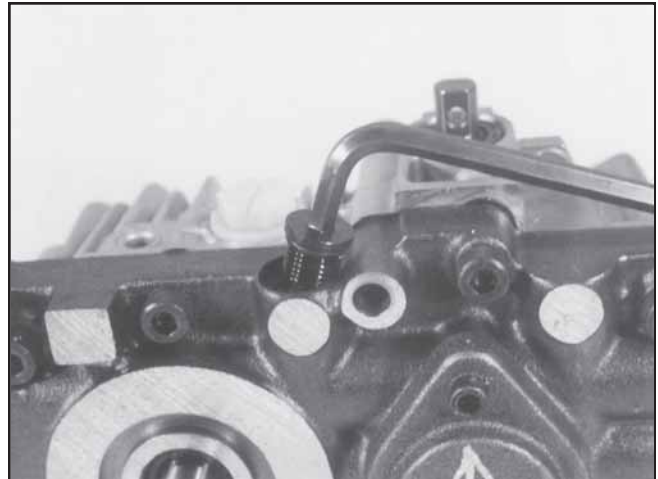

Check Valve Removal/Installation

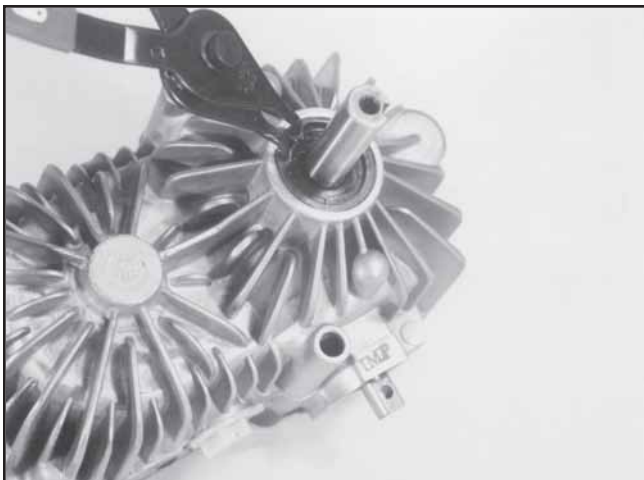

Retaining Ring Installation



Check Valve Options

Inspect the check balls (or poppets) and mating seats in the center section for damage or foreign material.

Position the transmission so that the check valve port will be in the upright position (as shown) and install the check ball (or poppet), spring and plug (with o-ring) into the center section. Make sure the plug stem is properly positioned into the poppet or damage and failure will occur. Be certain the check ball does not fall into the closed loop passage.

Torque the plug to 15-20 ft.lbs (20-27 Nm).

Turn the unit over and repeat the procedure for the other side.

Bypass Valve

Remove the bypass valve plug with a 9/16" hex wrench.

Remove the bypass valve plug, spool and spring from the transmission center section.

Inspect the valve spool and mating bore in the center section for damage or foreign material. The spool must move freely. It is recommended that the o-rings be replaced.

Retain the valve spring to the valve spool with petroleum jelly. Install the valve spool, spring and plug (with o-ring) into the center section. Torque the plug to 7-10 ft.lbs. (9.5-13.5 Nm).

Depress the bypass valve several times to insure that it operates smoothly and fully closes. The bypass "button" should extend from the hex plug approximately 0.22" (5.588 mm) when fully released (closed).

Easy Ride Valves

Remove the Easy Ride valve plug with a 11/16" open end wrench or socket.

Remove the spring, piston and sleeve from the center section.

Inspect the piston nose for damage.

Inspect the piston sleeve and spring for damage. The piston should slide freely in the sleeve, but should fit tight enough to create a vacuum.

Inspect the valve seat in the center section for damage. If the valve seat is damaged the center section must be replaced. Refer to the Major Repair section of this manual.

Install the piston, sleeve and valve spring.

Install the hex plug and torque to 15-20 ft.lbs. (20-27 Nm).



Bypass Valve



Easy Ride Valve

Charge Pump

The correct charge pump orientation is determined by the rotation of the pump shaft (CW or CCW). Before removing the charge pump, make note of, and/or mark its position to simplify the reassembly process.

NOTE: Unlike the BDU-10L, some BDU-21L transmissions have an implement circuit designed into the charge pump cover. These covers are different and are not reversible. It is very important that they are reassembled in the same orientation as they were removed.



BDU-10L CW



BDU-10L CCW

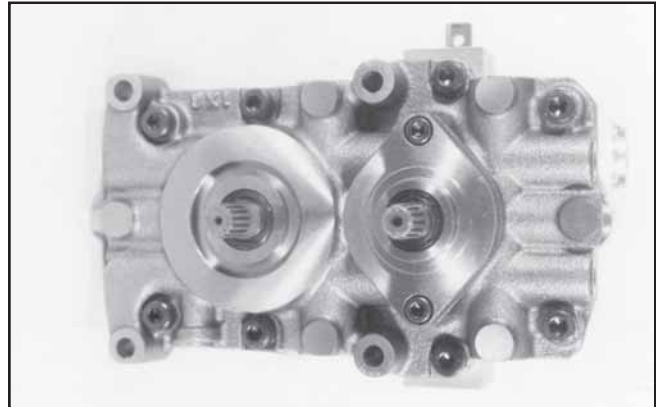

BDU-10L With Through Shaft Charge Pump

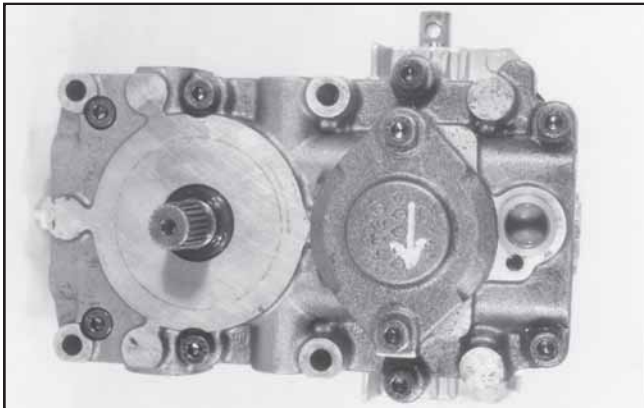

BDU-21L CW

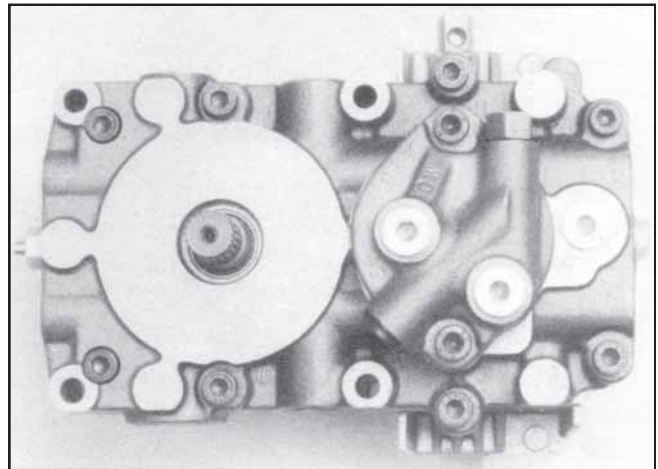

BDU-21L Aux. CW

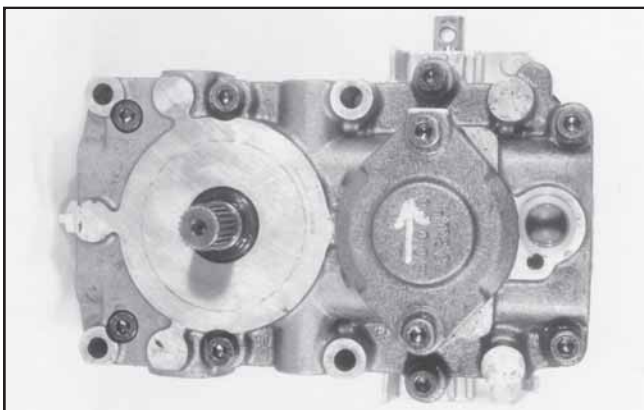

BDU-21L CCW

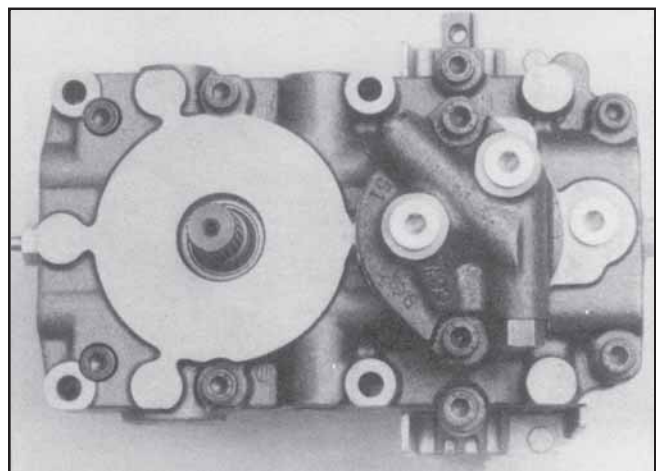

BDU-21L Aux. CCW

Disassembly Procedures

Using a 5 or 6mm internal hex wrench, remove the two (2) screws holding the charge pump cover to the center section.

Remove the charge pump cover and o-ring. Avoid turning or twisting the charge cover during removal, or damage to the charge relief valve spring may occur.

Remove the charge pump gerotor assembly.

For BDU-21L with implement circuit: Remove the charge pump shim, two aligning pins, two o-rings, the gerotor assembly and the charge pump drive pin. Make note of the top and/or bottom of the gerotor assembly.

For BDU-21L: Remove the charge pump drive pin.

For BDU-10L with a through shaft: Remove the charge pump drive pin, spacer plate and o-ring. Make note of the top and/or bottom of the spacer plate.

Remove the charge relief valve spring and ball.

NOTE: The BDU-21L with implement circuit has the charge relief valve spring and ball in the charge pump cover.

Inspect the gerotor assembly, charge pump cover, and center section (or spacer plate) for abnormal wear, damage or foreign material. Inspect the charge relief valve ball and spring. Inspect the charge relief valve seat in the center section for damage or foreign material.

Assembly Procedures

Prior to reassembly of the charge pump, apply a small quantity of petroleum jelly to the I.D., O.D., and faces of the gerotor assembly.

NOTE: Improper assembly of the charge relief valve spring and ball, or the incorrect orientation of the charge cover will cause a priming failure. If assembled properly, the charge pressure should be maintained at 25 to 70 PSI (1.72-4.82 bar) at 3000 RPM pump speed.

For BDU-10L Install the charge relief valve spring and ball. Install the gerotor assembly. Install a new o-ring and the charge pump cover. **NOTE:** The charge relief spring must enter the recessed hole in the charge pump cover. Torque the bolts evenly to 7-10 ft.lbs. (9.5-13.5 Nm).

For BDU-21L: Install the charge relief valve spring and ball. Install the drive pin. Install the gerotor assembly. Install a new o-ring and the charge pump cover. **NOTE:** The charge relief spring must enter the recessed hole in the charge pump cover. Torque the bolts evenly to 12-15 ft.lbs. (16.3-20.3Nm).



BDU-10L Charge Pump Components



BDU-10L Through Shaft Charge Pump Components

For BDU-10L models with through shaft: Install the charge relief valve spring and ball. Install a new o-ring and the spacer plate onto the aligning pins paying attention to the correct orientation. **NOTE:** The charge relief spring must enter the recessed hole in the spacer plate. Install the charge pump drive pin. Install the gerotor assembly. Install a new o-ring and charge pump cover. Torque the bolts evenly to 7-10 ft.lbs. (9.5-13.5 Nm).

Charge Pump Assembly Procedures

For BDU-21L with implement circuit: Install the drive pin. Install a new o-ring on each side of the gerotor assembly and position the gerotor assembly onto the aligning pins in the same orientation as it was removed. Install the charge pump shim and the charge pump cover. Torque the bolts evenly to 18-25 ft.lbs. (24.4-33.9 Nm).



BDU-21L Charge Pump Components



BDU-21L/A CW Charge Pump Components



BDU-21L/A CCW Charge Pump Components

Major Repair

General Information

Major repairs described in the following sections are for the complete disassembly and reassembly (Major Repair) of the transmission and will void all product warranty, unless license to perform said major repairs was previously obtained from an authorized representative of HYDRO-GEAR.

Cleanliness is a primary means of assuring satisfactory life on repaired units. Cleaning parts by using solvent wash and air drying is usually adequate. As with any precision equipment, all parts must be kept free of foreign materials and chemicals.

Protect all exposed sealing surfaces and open cavities from damage and foreign material. The outer surfaces should be cleaned before beginning any repairs.

It is recommended that all O-rings and seals be replaced. Lightly lubricate all O-rings and seals with a clean petroleum jelly prior to assembly.

It is recommended that parts requiring replacement be replaced with the complete assembly (kit) as shown in the service parts drawings on pages 22-27.

Prior to performing major repairs on the BDU Hydrostatic Transmission, remove the transmission from its installed location and remove any external components such as a cooling fan and input pulley or frame mounting hardware.

NOTE: Thoroughly clean all exposed surfaces prior to any further disassembly.

Remove the oil lines (hoses and fittings) so that as much oil as possible can be drained from the housing.

Disassembly Procedures

Prior to performing major repairs on the BDU remove the external components as described in the Minor Repairs section of this manual. These include the following:

- Bypass Valve
- Charge Check Valves
- Charge Pump Assembly

Using a 6 mm internal hex wrench, remove the eight screws which retain the center section to the housing.

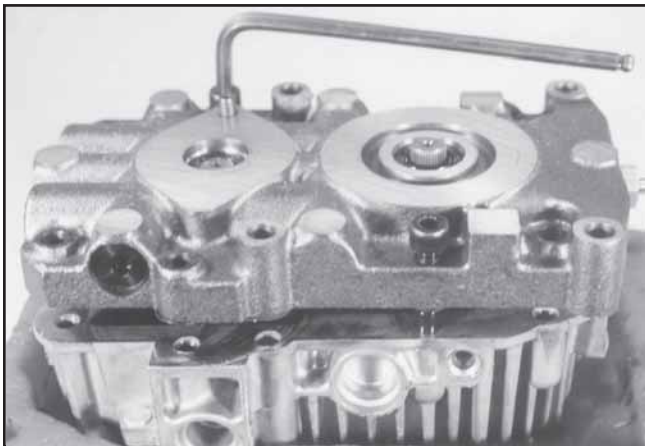

BDU-10S Center Section Removal

The internal springs of the pistons should separate the center section from the housing. Remove the center section from the housing.

CAUTION: The cylinder blocks may stick to the surface of the center section. Exercise caution to prevent damage to the components.

Remove the gasket and two aligning pins from the housing. The gasket will not be reusable.

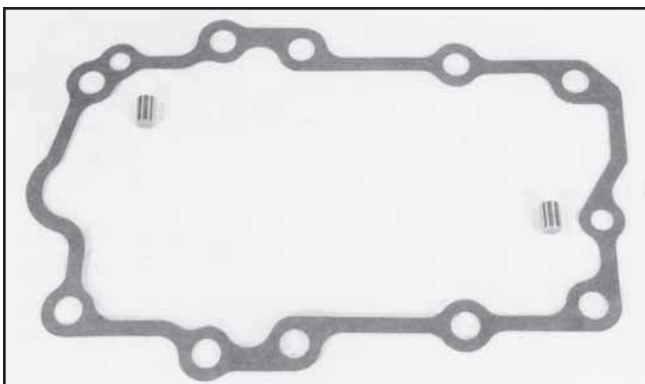

BDU-10S Aligning Pins and Gasket

For BDU-10S remove the filter element, filter washer and spring from the housing.

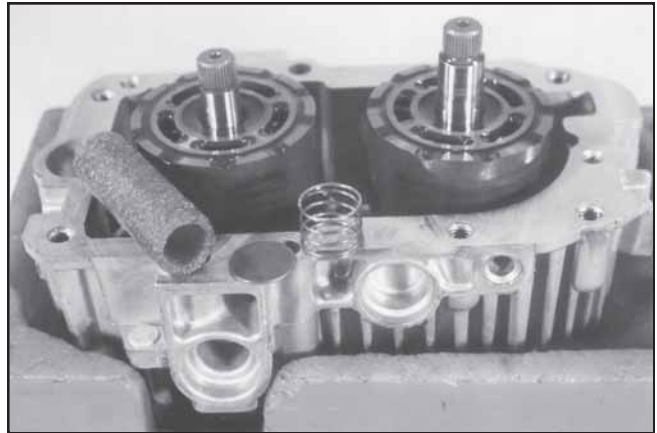

BDU-10S Filter Removal

Remove the pump cylinder block kit from the pump shaft. Inspect the splines on the shaft and in the pump block for damage or excessive wear. Check the pistons and block bores for excessive wear. The pistons should fit with very little side clearance in the block bores, but must slide freely. **NOTE:** The correct bore diameter for 21cc blocks is 0.6776 to 0.6784 while the 10cc blocks should be 0.6295 to 0.6303. 21cc pistons should be 0.6770 to 0.6767 and the 10cc pistons should be 0.6291 to 0.6288.

Remove the pump cylinder block spring and thrust washer from the pump shaft.

Remove the motor cylinder block kit and shaft assembly from the housing. Check the pistons and block bores for excessive wear. The pistons should fit with very little side clearance in the block bores, but must slide freely. Inspect the splines for damage or unusual wear. Replacement of the complete assembly is recommended if damage or excessive wear is found.



Remove Cylinder Blocks

Disassembly Procedures

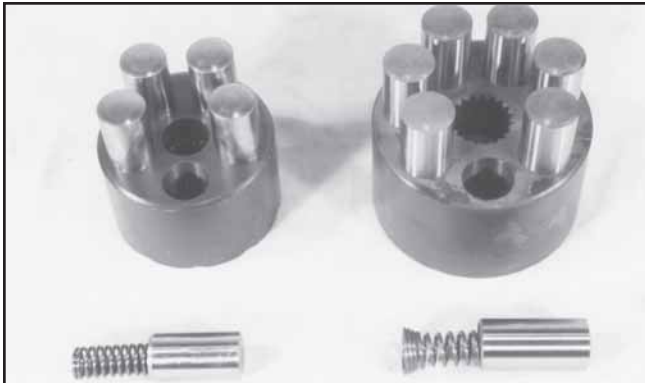

10CC and 21CC Cylinder Block Kit Components

Remove the motor thrust bearing assembly from the housing.

Remove the swashplate assembly and cradle bearings (BDU-10 only) from the housing.

NOTE: The cradle bearings in newer BDU-21L transmissions are not removable from the housing. If damage is present, a new housing kit is necessary.

Inspect the cradle bearing's low friction coating for wear. Inspect the swashplate and thrust bearing for any unusual wear or damage. If damage to the swashplate or cradle bearings is found then inspect the housing for possible damage. Replace complete assemblies as necessary.

Remove the slot guide block from the displacement control shaft.



Swashplate, Cradle Bearings, Block Spring and Washer Removed

Remove the input shaft lip seal retaining ring.

Pull the lip seal out of the housing bore. A hook type tool may be used to pry the seal out. Care must be taken to avoid damage to the housing bore, shaft sealing surface or bearing. Once removed, the seal is not reusable.

Remove the bearing spacer washer.

Remove the pump shaft assembly from the housing.

Inspect the splines on the shaft for damage or unusual wear.

Inspect the bearing. Replacement of the assembly is recommended if any damage or excessive wear is found.



BDU-10 Pump Shaft Components



BDU-21 Pump Shaft Components

Remove the displacement control shaft from the housing.

Remove the displacement control shaft lip seal from the housing. Care must be taken to avoid damage to the housing bore.

Inspect the housing for damage.

Disassembly Procedures



Housing, Control Arm and Lip Seal

Inspect the control shaft journal bearing for excessive wear. The BDU 10 control shaft journal bearing should be 0.4722 to 0.4733 while the BDU 21 control shaft journal bearing should be 0.5904 to 0.5908.

Inspect the BDU-10 motor shaft journal bearing for excessive wear. The BDU 10 motor shaft journal bearing should be 0.4961 to 0.4998.

Inspect the BDU-21 motor shaft needle bearing for damage.

If excessive wear or damage is found, replace the complete housing assembly.

Inspect the center section for damage to the cylinder block running surface.

Inspect the BDU-10 pump shaft journal bearing for excessive wear. The journal bearing should be 0.4998 to 0.4961.

Inspect the needle bearing for damage. If any damage or excessive wear is found, replace the complete center section assembly.

Reconditioning and Replacement of Parts

After disassembly, all parts should be thoroughly cleaned in a suitable solvent.

Inspect all parts for damage, nicks or unusual wear patterns. Replace all parts having unusual, excessive wear or discoloration.

Inspect the sealing surfaces, bearing surfaces, and shaft splines. Polish the sealing areas on the shafts if necessary. Replace any worn or damaged parts.

The running surfaces of the cylinder blocks **MUST** be flat and free from scratches. If scratches or wear are found on the running surface of the cylinder block or center section, replace the parts.

Assembly Procedures

Clean and lightly oil parts prior to assembly of the BDU transmission.

Be sure to torque all threaded parts to the recommended torque levels.

Replace all o-rings, gaskets and shaft seals.

CAUTION: Most parts have critical high tolerance surfaces. Care must be exercised to prevent damage to these surfaces during assembly. Protect exposed surfaces, openings, and ports from damage or foreign material.

Install the displacement control shaft.

Assembly Procedures

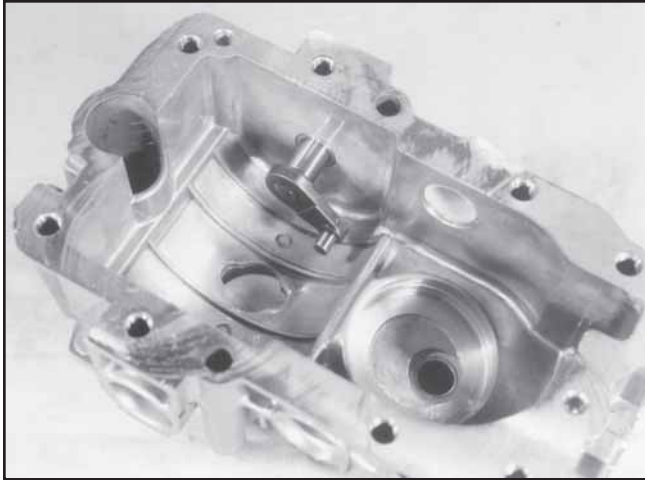

BDU-10 Control Arm Installation

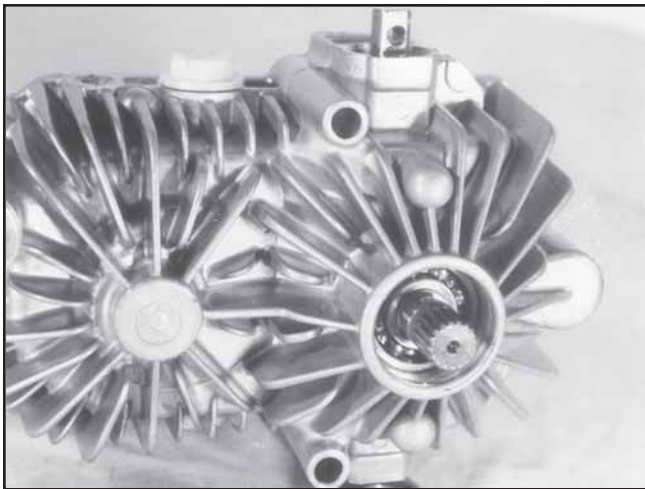

BDU-10 Pump Shaft Installation

Install the pump shaft assembly into the housing.

Install the bearing spacer washer.

Install the lip seal and retaining ring as described in the minor repair section.

Install the cradle bearings. (BDU-10 only)

Install the slot guide block onto the displacement control shaft.

Install the swashplate into the housing. The slot on the swashplate must engage the slot guide block on the displacement control shaft. Use a tool such as a screwdriver or scribe to hold the guide block in position while installing the swashplate.



BDU-10 Swashplate Components

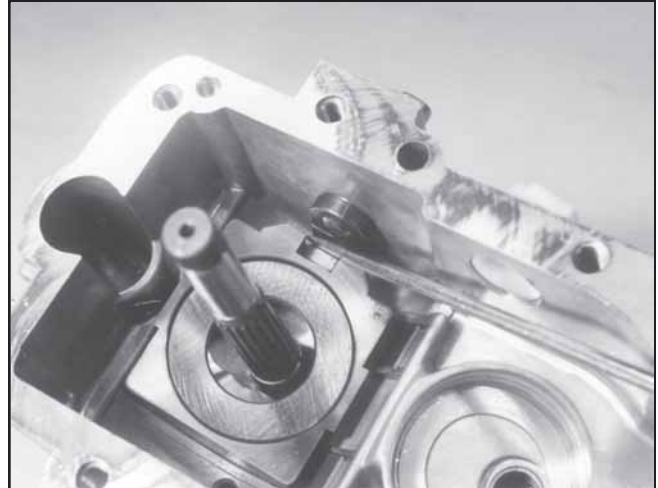

BDU-10 Swashplate Installation

NOTE: As a product improvement, since July 1, 1993 the BDU-21 thrust bearings for both the motor and pump are now the same. They are not interchangeable with the old versions. New housing kits, or new swashplate kits will be necessary to accommodate new thrust bearings.



BDU-21 Swashplate Components

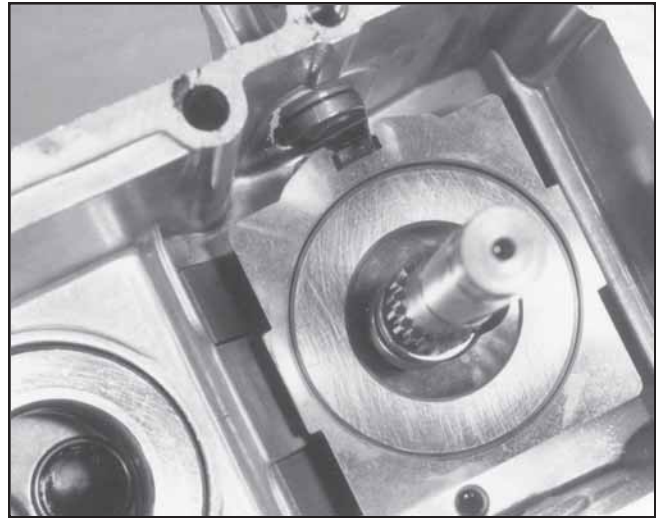

BDU-21 with Swashplate Installed

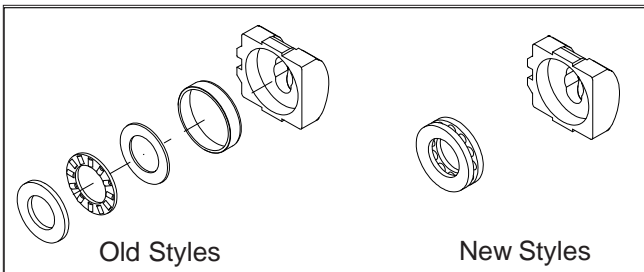

BDU-21 Swashplate Changes

Hold the swashplate in position and measure the end play of the displacement control shaft using a dial indicator or a depth gauge. Using a suitable sleeve, press the control shaft bearing into the housing until the control shaft end play is between 0.020" and 0.060" (.508-1.52 mm).

Install the thrust washer and pump cylinder block spring onto the pump shaft.

Install the springs piston washers and pistons into the cylinder block. The pistons must move freely in their bores.

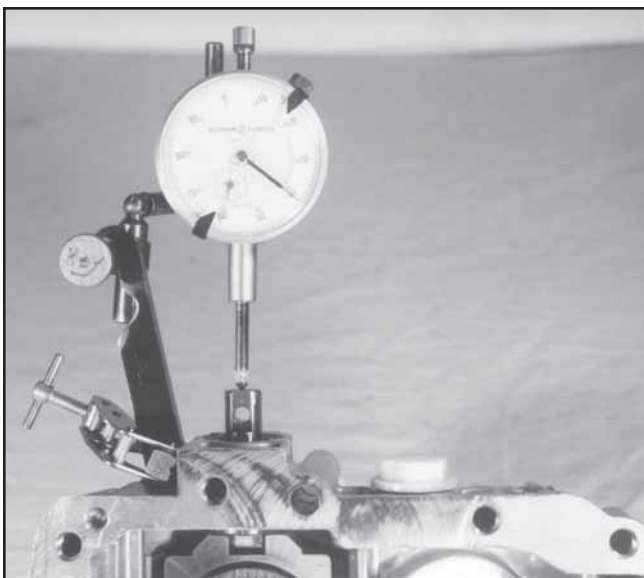

Measure Control Arm End Play



BDU-10 Cylinder Block Kit

Assembly Procedure

NOTE: To simplify the installation of both the motor block and the pump block kits, wrap a rubber band snugly around the pistons. This is intended to hold the pistons in their bores as the block kits are handled during installation.



BDU-21 Cylinder Block Kit with Rubber Band

With the swashplate in the “neutral” (0 angle) position and the transmission housing laying on its side, install the pump cylinder block kit onto the pump shaft in the housing.

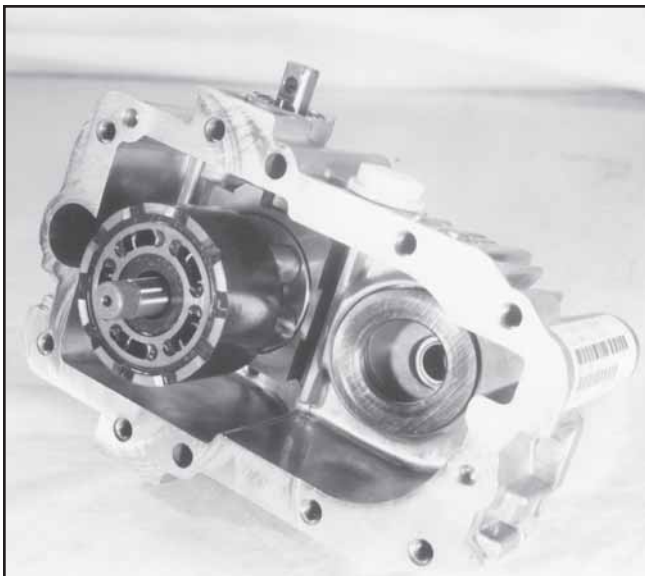

BDU-10 with Pump Block Installed

Install the motor thrust bearing into the housing.

NOTE: It will be necessary to have a DRY journal bearing to prevent a hydraulic lock while installing the motor shaft.

Install the motor shaft/cylinder block kit. Use caution to prevent damage to the journal bearing while guiding the shaft into position. Once installed, it will be necessary to hold the assembly in position until the center section has been installed.

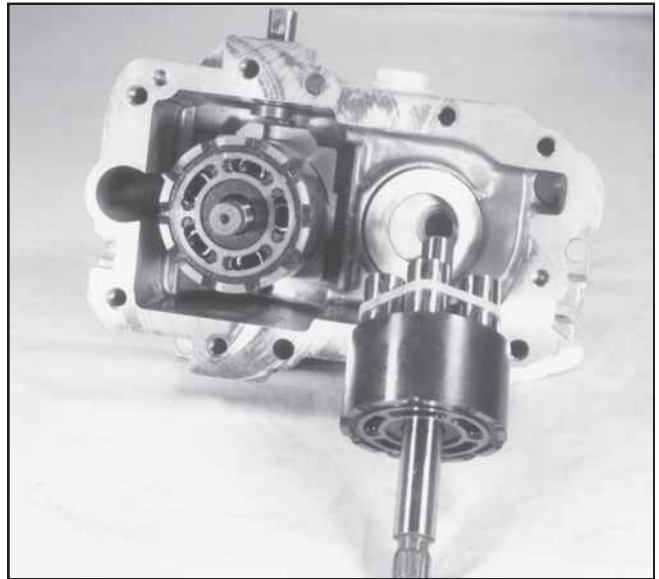

BDU-10 Motor Shaft Kit Installation

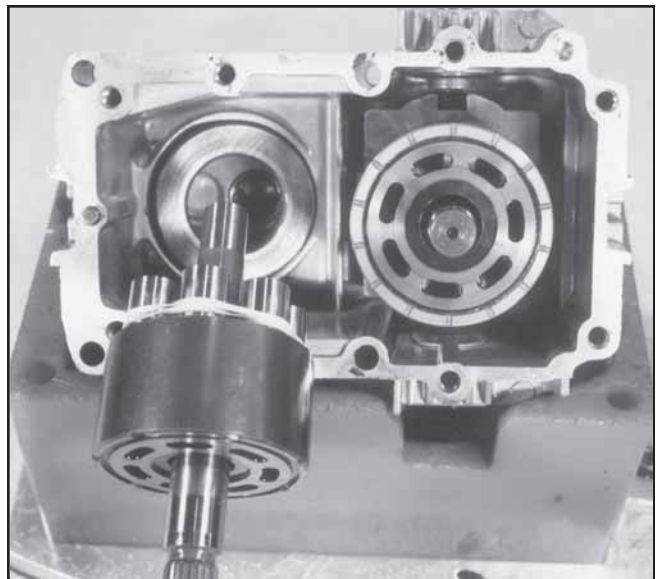

BDU-21 Motor Shaft Kit Installation

For BDU-10 Check to see that the piston springs are centered in the cylinder block bores. If necessary, position them with a small screwdriver. Use caution to avoid damage to the cylinder block face.

For BDU-10S Install the filter spring, washer and new filter element.

Install the two aligning pins, and install a new gasket onto the housing.

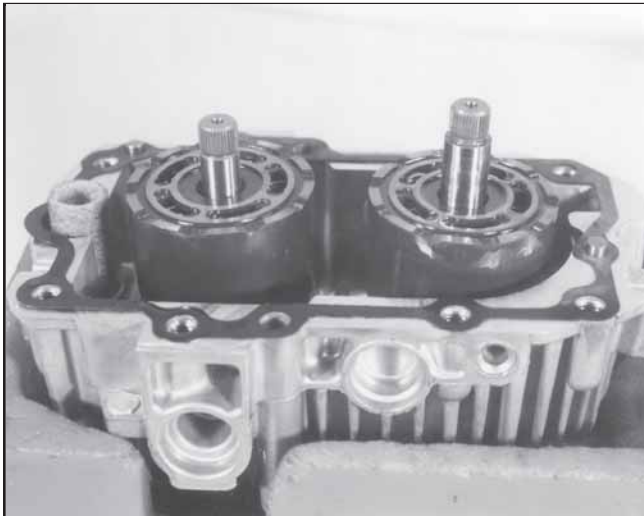

BDU-10

Lubricate the running surfaces of the cylinder blocks and the center section.

Position the housing with the housing opening UP, and install the center section onto the housing while holding the motor shaft in position in the housing journal bearing.

CAUTION: Make sure all parts are properly aligned. Do not use excessive force.

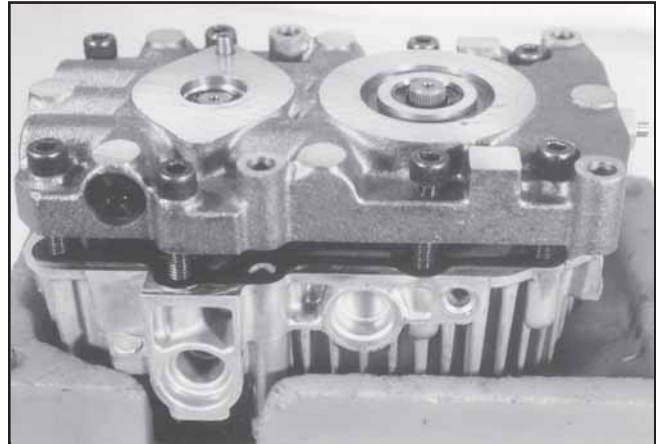

BDU-10 Center Section Assembly

Install the eight bolts and torque evenly to 10-15 ft.lbs. (13.56-20.34 Nm).

Rotate the shafts a minimum of two turns to assure correct assembly. When properly assembled the shafts should require minimal torque to turn, approximately 15 in. lbs. (1.7 Nm) maximum.

Refer to the Minor Repairs section in this manual to complete reassembly of the BDU transmission.

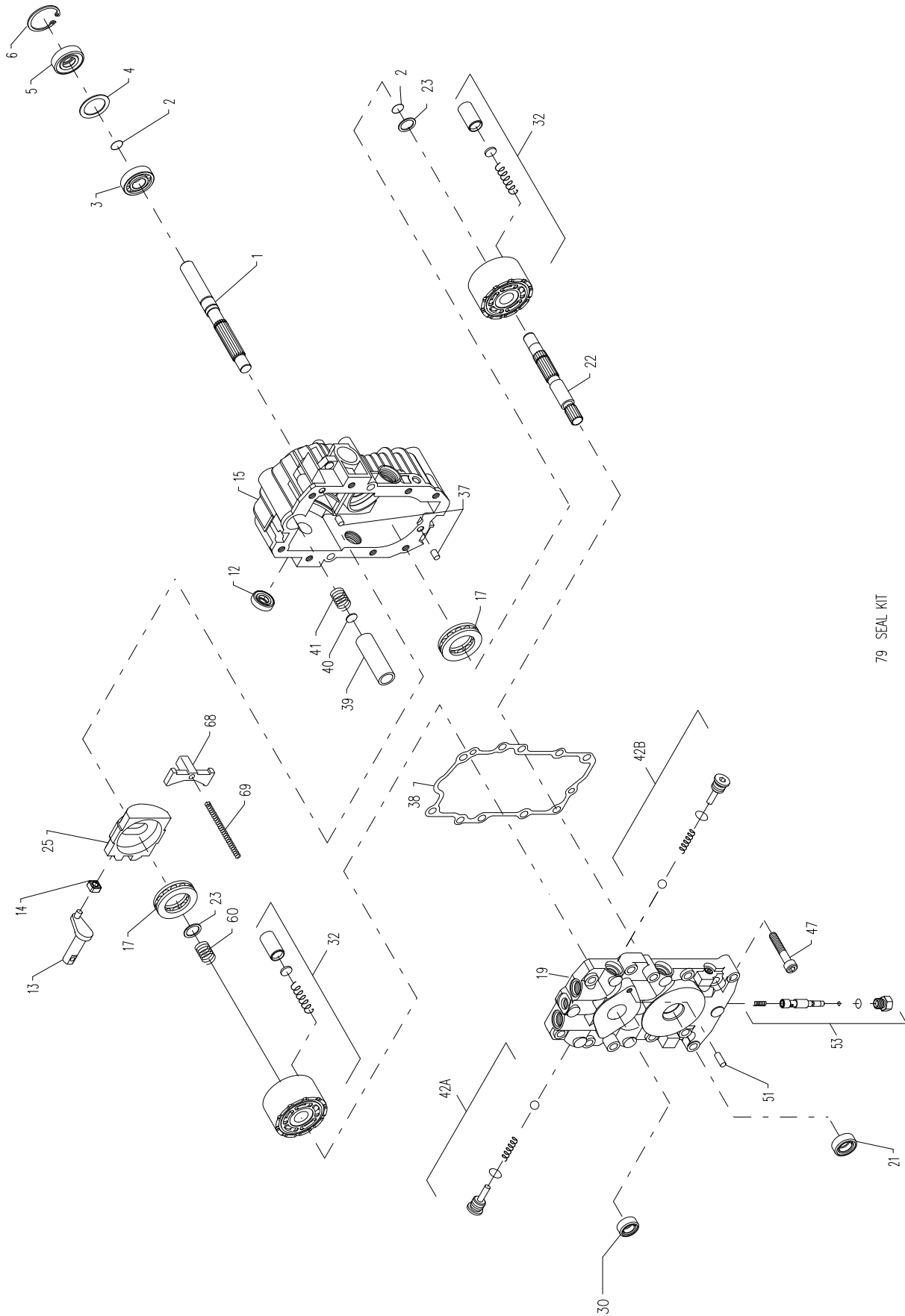

79 SEAL KIT

PARTS LIST

NO.	DESCRIPTION	NO.	DESCRIPTION
1	PUMP SHAFT	25	VARIABLE SWASHPLATE
2	WIRE RETAINING RING	30	LIP SEAL
3	SHAFT BALL BEARING	32	BLOCK ASSEMBLY
4	SPACER	37	PIN - STRAIGHT HEADLESS
5	LIP SEAL	38	CENTER SECTION GASKET
6	RETAINING RING	39	FILTER
8	CRADLE BEARING	40	THRUST WASHER
12	LIP SEAL	41	FILTER SPRING
13	TRUNNION ARM	42	CHECK VALVE KIT
14	SLOT GUIDE	47	SOCKET HEAD CAP SCREW
15	HOUSING KIT	51	PIN - SPIRAL
17	THRUST BALL BEARING ASSY	53	BYPASS VALVE KIT
19	CENTER SECTION ASSEMBLY	60	BLOCK SPRING
21	LIP SEAL	68	LEVELER
22	MOTOR SHAFT	69	HELICAL COMPRESSION SPRING
23	BLOCK THRUST WASHER		

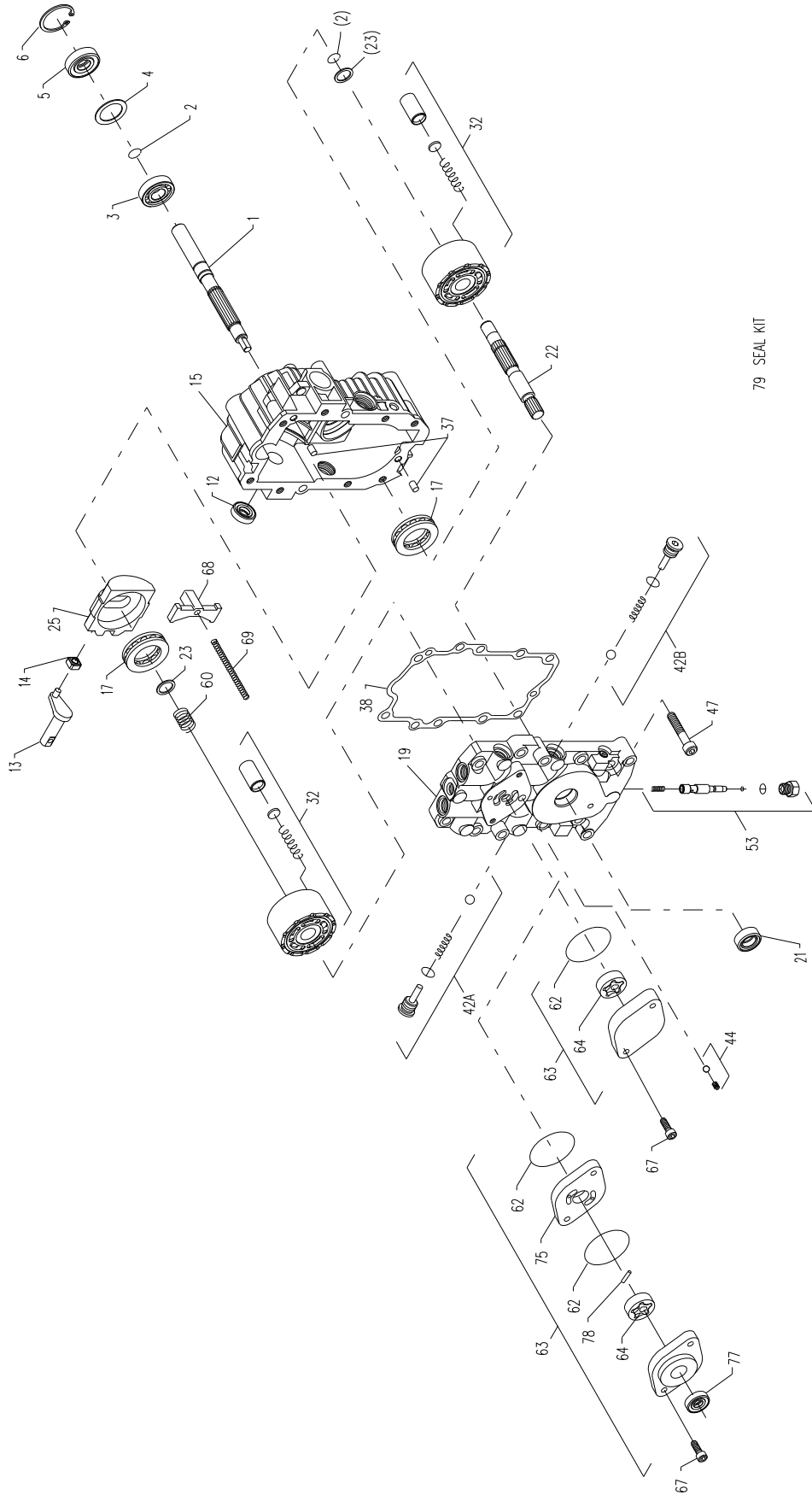

PARTS LIST

NO.	DESCRIPTION	NO.	DESCRIPTION
1	PUMP SHAFT	37	PIN ST HDLS
2	WIRE RETAINING RING	38	CENTER SECTION GASKET
3	SHAFT BALL BEARING	42	CHECK VALVE KIT
4	SPACER	44	CHARGE RELIEF KIT
5	LIP SEAL	47	SOCKET HEAD CAP SCREW
6	RETAINING RING	53	BYPASS VALVE KIT
12	LIP SEAL	60	BLOCK SPRING
13	TRUNNION ARM	62	O-RING
14	SLOT GUIDE	63	CHARGE PUMP KIT
15	HOUSING KIT	64	GEROTOR ASSEMBLY
17	THRUST BALL BEARING ASSY	67	CAP SCREW
19	CENTER SECTION ASSEMBLY	68	LEVELER
21	LIP SEAL	69	HELICAL COMP SPRING
22	MOTOR SHAFT	75	SPACER PLATE
23	BLOCK THRUST WASHER	77	SEAL-LIP
25	VARIABLE SWASHPLATE	78	HEADLESS PIN
32	BLOCK ASSEMBLY		

PARTS LIST

NO.	DESCRIPTION	NO.	DESCRIPTION
1	PUMP SHAFT	31	VARIABLE SWASHPLATE
2	RETAINING RING	39	O-RING
3	RETAINING RING	40	CHARGE PUMP KIT
4	SPACER	41	GEROTOR KIT
5	SHAFT BEARING	42	CHECK VALVE KIT
6	PUMP SHAFT LIP SEAL	44	CHARGE RELIEF VALVE KIT
12	TRUNNION LIP SEAL	45	AUX RELIEF VALVE KIT
13	TRUNNION ARM	46	PIN
14	SLOT GUIDE	49	AUX BYPASS/CHECK KIT
15	HOUSING KIT	50	BYPASS VALVE KIT
17	THRUST BALL BEARING ASSY	52	PLUG
19	BLOCK THRUST WASHER	54	AUX FILTER KIT
20	BLOCK SPRING	57	SOCKET HEAD CAP SCREW
21	PUMP CYLINDER BLOCK KIT	58	SOCKET HEAD CAP SCREW
22	MOTOR SHAFT	66	PLUG
23	LIP SEAL	67	FILTER COVER
25	CENTER SECTION KIT	69	PIN
26	PIN	75	CHARGE PUMP SHIM
27	CENTER SECTION GASKET	84	EASY RIDE VALVE KIT
38	MOTOR CYLINDER BLOCK KIT		



© 2009 HYDRO-GEAR
Printed in U.S.A.
Rev. P5